

Training Systems for Electrical Power Engineering

The Smart Power Engineering Lab

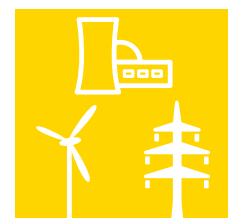

Contents

Qualifications Through Quality	
Training Systems for Electrical Power Engineering	4
Animated Presentation of Complex Training Material	
Project-based Training Media – Adaptable to any Training System	5
From Power Generation Through to Consumption	
The Intelligent Electrical Power Grid of the Future	6
Networked Systems in the Power Engineering Lab	8
Well-equipped for the Future	10
SCADA Power-LAB Software	11
The Entire System at a Glance	12
More Than Just a Training System	
The Power Engineering Lab is a Complete Solution	14



Contents

Fundamentals of Power Engineering	16
DC, AC and Three-phase Technology (UniTrain-I)	20
Magnetism/Electromagnetism (UniTrain-I)	23
Measurements with the Multimeter (UniTrain-I)	24
Mains Systems and Models (UniTrain-I)	25
Current and Voltage Transformers	26
Power Generation	28
Three-phase Synchronous Generators (UniTrain-I)	32
Automatic Generator Control and Synchronisation	33
Generator Protection	35
Renewable Power Generation	38
Photovoltaics (UniTrain-I)	42
Advanced Photovoltaics	44
Wind Power Plants	48
Fuel Cell Technology (UniTrain-I)	54
Advanced Fuel Cell Technology	56
Transformers	58
Three-phase Transformers (UniTrain-I)	62
Investigating Transformers	63
Transformer Protection	64
Power Transmission	66
Investigations on Three-phase Transmission Lines	70
Parallel and Series Connection of Transmission Lines	71
Transmission Line with Earth-fault Compensation	72
Transmission Systems with Synchronous Generator	73
Line Protection	74
Power Distribution	78
Three-phase Double Busbar System	82
Overcurrent Protection for Double Busbars	83
Power management	84
Complex loads, Power Consumption Metering and Peak Load Monitoring	88
Dynamic Loads	89
Manually-operated and Automatic Reactive Power Compensation	90
Protection of Electric Loads	91

Qualifications Through Quality

Training Systems for Electrical Power Engineering

Advances in technology ...

The transition in the energy industry away from coal, oil and nuclear power towards renewable energy sources is gaining momentum. Today, technology is so advanced that solar energy, wind power, hydrogen power and biomass can be exploited as environmentally friendly energy sources.

In order for this trend to continue, well-trained technicians and specialists are needed all over the world.

In the wake of so-called intelligent (smart) power grids, people all over the world are talking about power generation, transmission and distribution as well as the protection of power engineering facilities and the economic exploitation of energy.

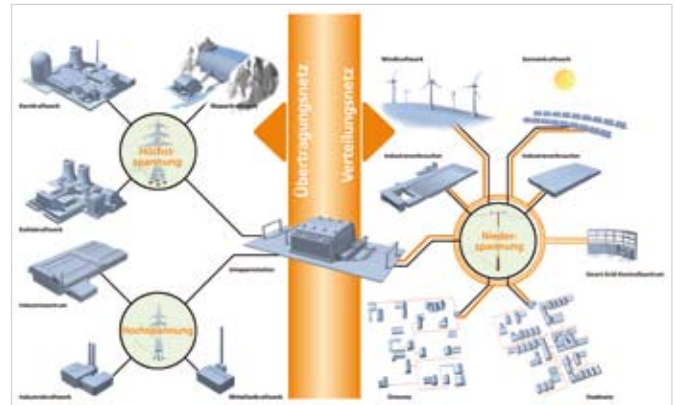

... are having a huge impact on training and education

Now, the Lucas-Nülle training system on power engineering gives instructors the opportunity to demonstrate and convey the technological context of power engineering to students in a graphic and practice-oriented fashion.

Electrical power engineering includes the areas of power generation, transmission, distribution and electrical energy utilisation as well as safety protective measures used in these areas.

The system is so extremely versatile that it can be adapted to fit all of the wide-ranging training requirements applicable to skilled workers, technicians or even engineers.



Your benefits

- Comprehensive, well-rounded program – spanning power generation and distribution techniques all the way to energy usage and consumption
- Integration of renewable energies into conventional power engineering
- System monitoring and controlling using SCADA (Supervisory Control and Data Acquisition)
- Modularly designed experiment panel system for the step-by-step, experiment-based exploration of system interdependencies
- Bus structure of all voltage levels permits rapid and transparent experiment setup
- Realistic simulation model of a 380-kV transmission line with 300-km and 150-km sections
- Use of conventional industrial components in cutting-edge digital technology
- High work-safety standards through the exclusive use of safety sockets and safety connecting leads
- Protective technology measures for all areas of power engineering

Animated Presentation of Complex Training Contents

Project-based Training Media – Adaptable to any Training System

Manuals

Manuals provide, in addition to detailed descriptions of the experiments, also numerous projects, examples, exercises and solutions.

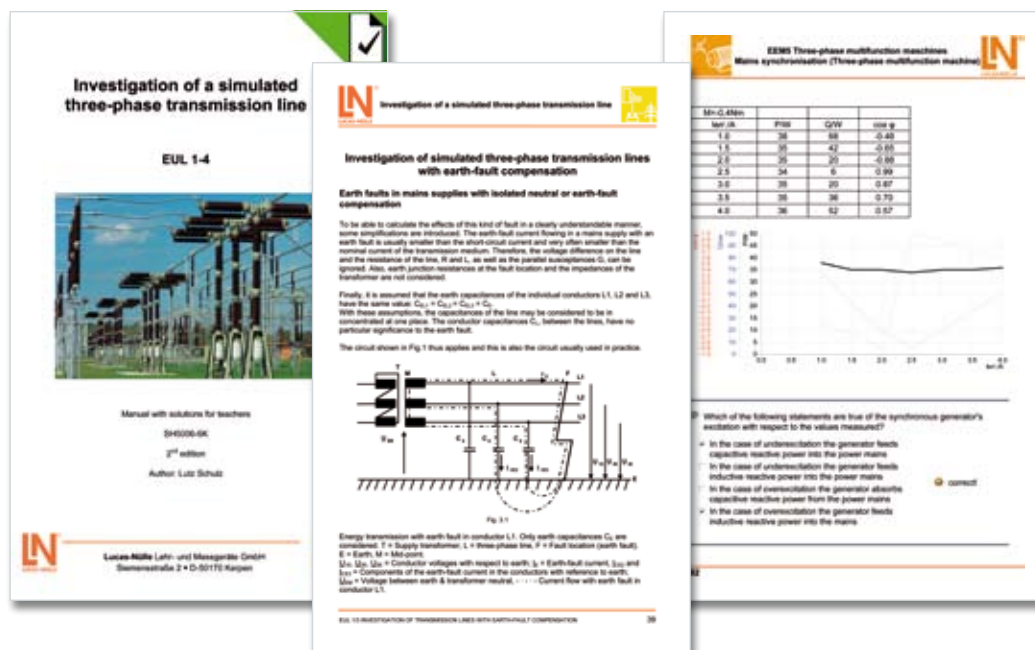

Multimedia courses

Many experiment instructions are available in the form of multimedia courses. This permits direct access to the measurement results of many different instruments. The multimedia courses contain:

- Questions to monitor knowledge level and learning
- Interactive experiment setups
- Navigation bars
- Animated sections devoted to theory

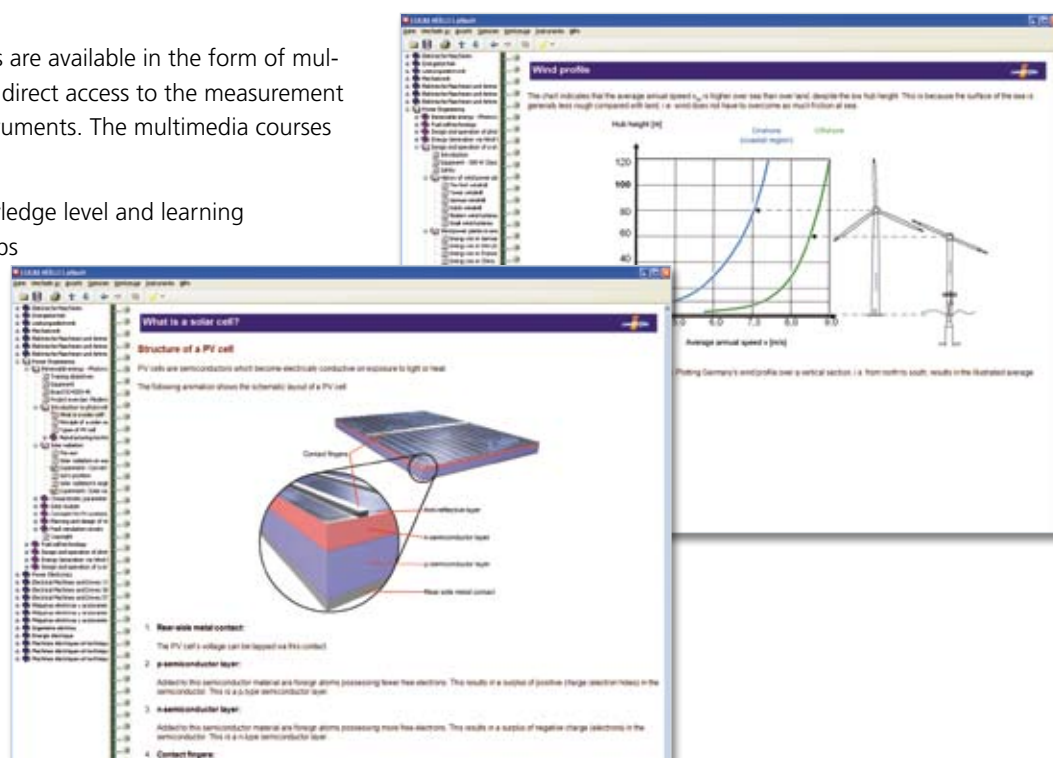

From Power Generation Through to Consumption

The Smart Electrical Power Grid of the Future

Using the Lucas-Nülle equipment sets, it is possible to model an entire power supply grid from power generation all the way to ultimate consumption.

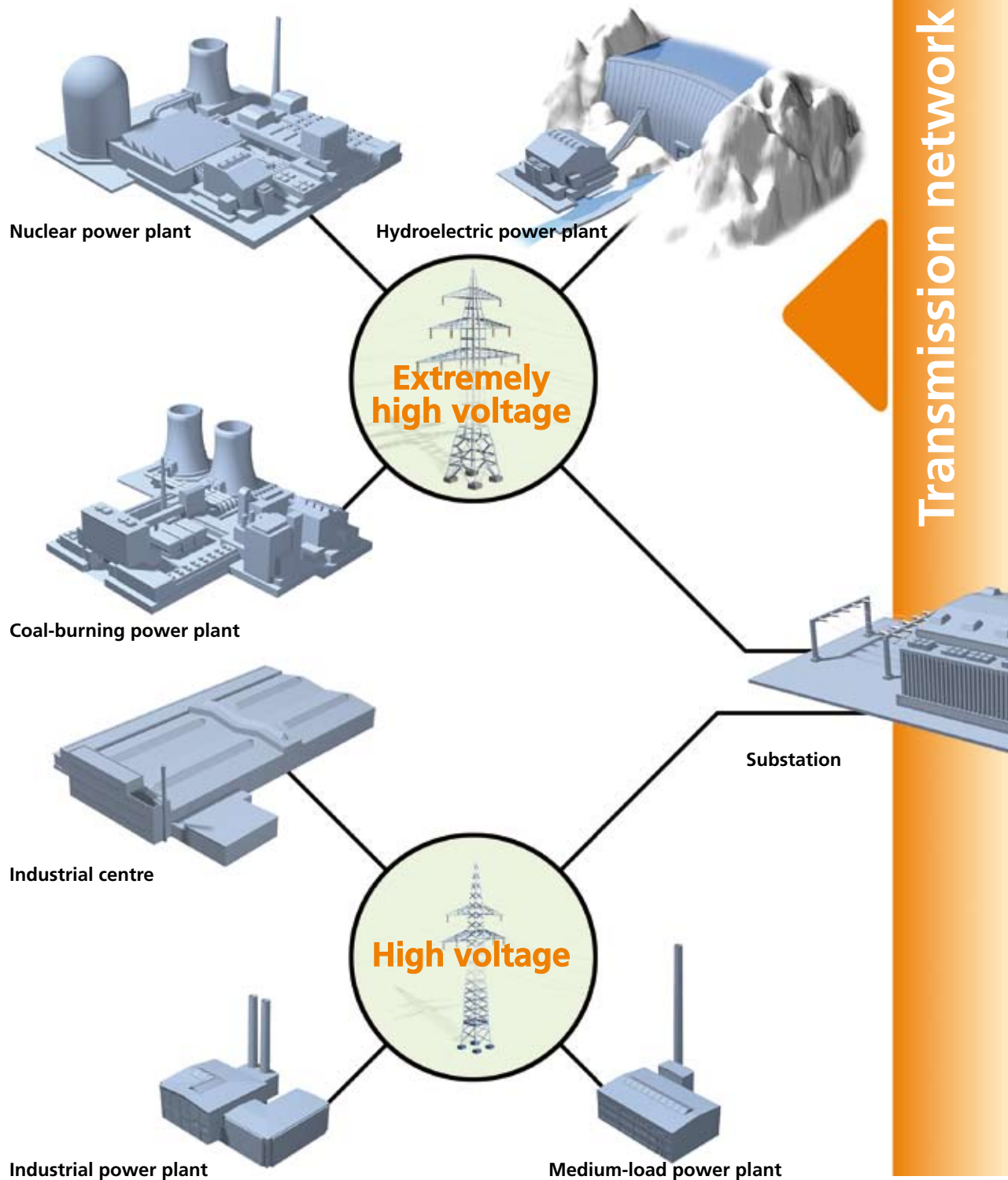

Distribution network

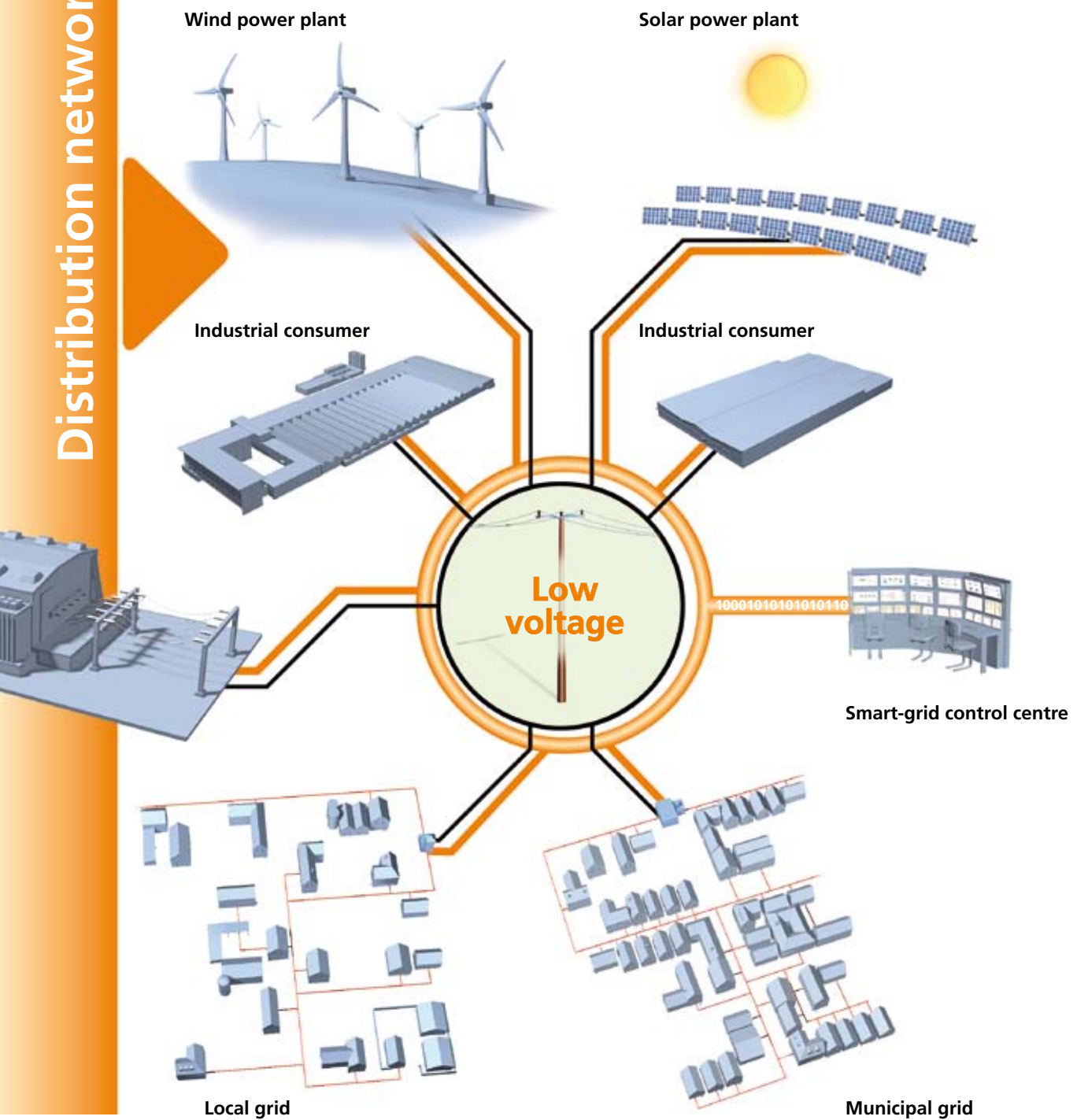

From Power Generation Through to Consumption

Networked Systems in the Power Engineering Laboratory

The smart lab

The power engineering equipment sets from Lucas-Nülle GmbH can be combined with each other as required. Accordingly, you can, for example, take the power obtained from renewable energy sources and transmit this power via a line model, use a transformer to step it up or down and distribute it to any number of consumers using the double busbar. Additionally, the bus systems of the measurement and protective equipment can all be interconnected, centrally evaluated and controlled using SCADA for Power-LAB software. Accordingly, all of the obstacles to the design and investigation of intelligent power grids in the lab have been overcome.

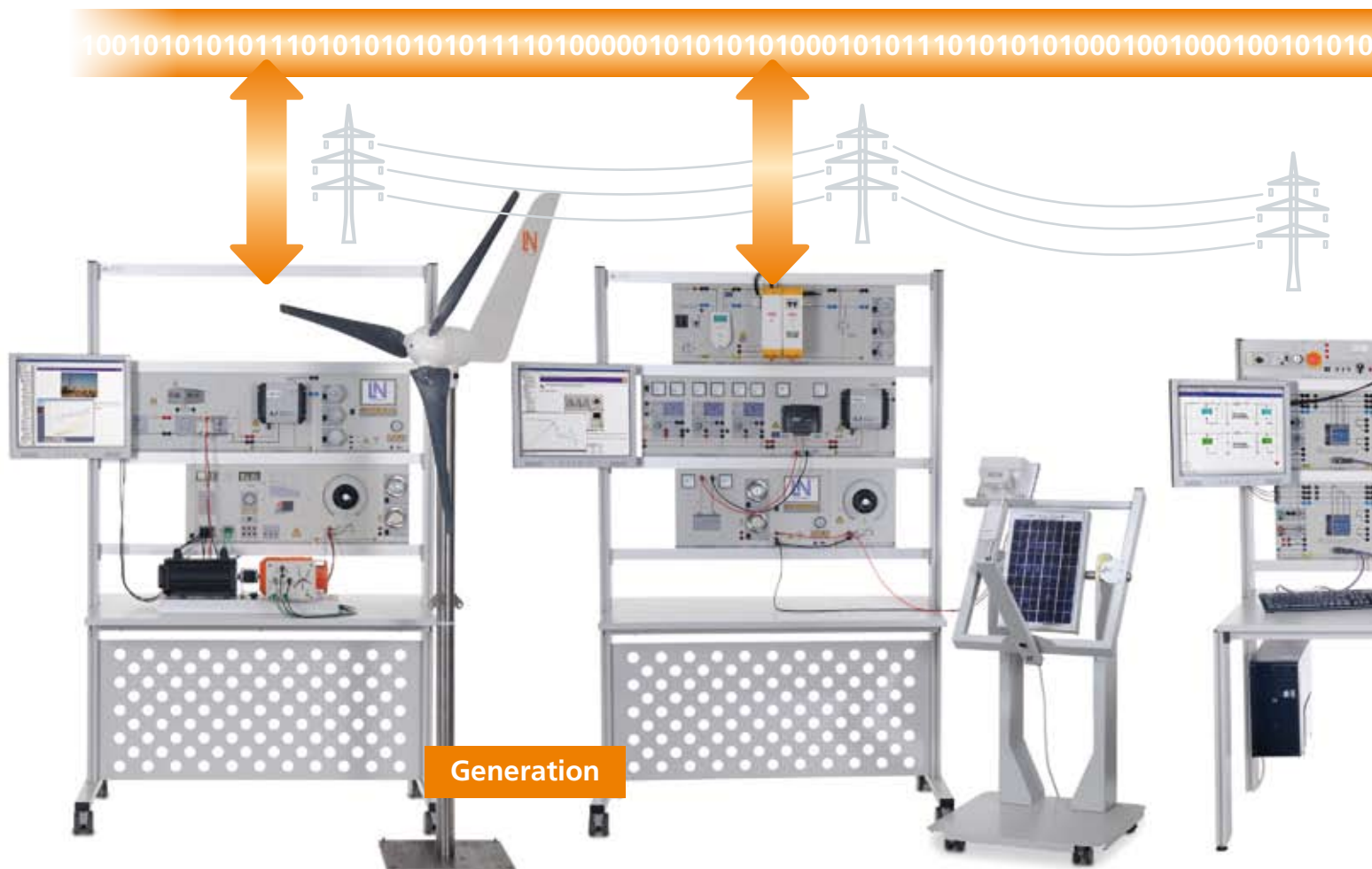



1001001010100101011100010101010100010101010000101001010010001000100101000101010



Transmission



Distribution



Consumption

From Power Generation Through to Consumption

Well Equipped for the Future

Intelligent power mains or the “smart grid”

In the future, new technology will better equip the power grid for the demands of tomorrow. More flexible grid management should make the increasing proportion of renewable energy sources compatible with conventional infrastructures associated with the power stations.

The variety and number of these decentralised power plants require a revision in how we manage power grids – the so-called intelligent or “smart grid”:

- Improving coordination of energy requirements and generation
- Using modern IT technology, like internet, sensors, control systems and wireless transmission devices
- “Smart metering” – digital current meters measure current consumption at end points of the grid
- Shifting household consumption away from peak load periods
- Starting flexible applications such as washing machines outside the peak load periods initiated by the utility provider

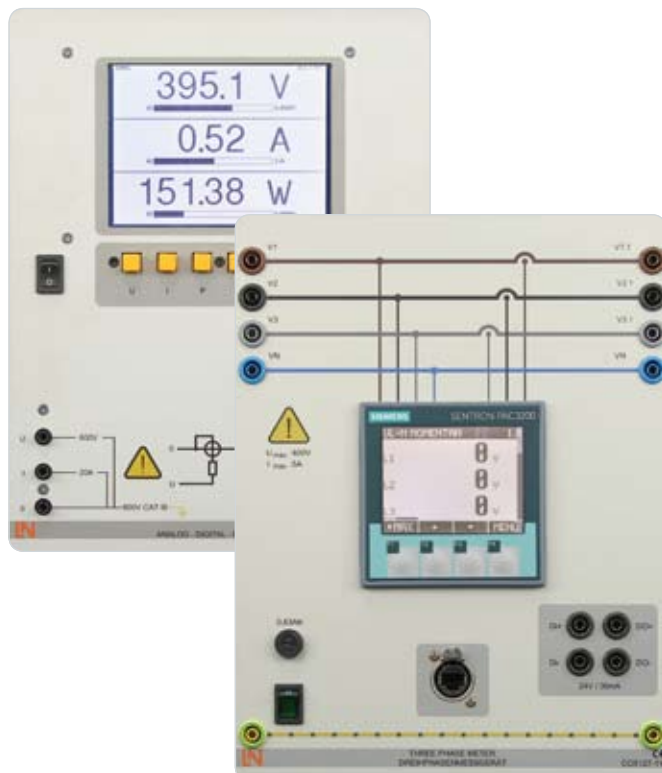

The training systems from Lucas-Nülle have been designed in anticipation of these developments:

- Smart measuring instruments which avail of various communication interfaces (e.g. LAN, RS485, USB) and control elements
- SCADA Power-LAB software for the intelligent control and evaluation of the “smart grid”

SCADA Power-LAB Software

By Supervisory Control and Data Acquisition (SCADA), we mean the monitoring, control and data acquisition of technical processes as they happen in real time. In electrical power engineering, SCADA is used to cover the entire spectrum from power generation, transmission – including protection measures – and power utilisation.

SCADA provides technicians with the opportunity of tracking and entering data into these processes. Measurement values are displayed on the screen in real time. Control signals can be modified during these processes. The SCADA system can also control these processes automatically. The recording of so many measurement values permits not only better future planning but also economic optimisation. The system can also be remotely controlled using local access networks (LAN).

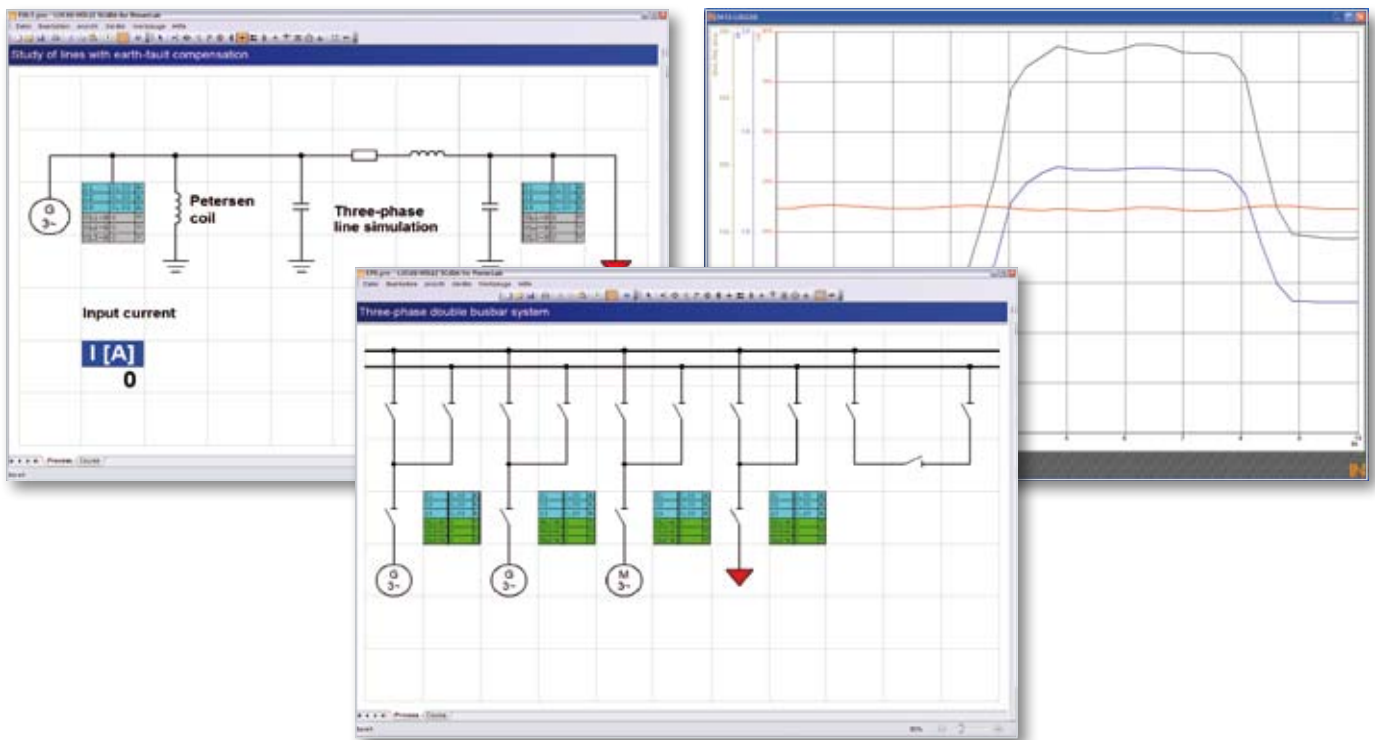

Your benefits

- All of the Lucas-Nülle power engineering equipment components can be arranged as symbols on the screen
- Measured values and operating states are displayed
- Important parameters and signals can be controlled by the software
- The measurement values of the equipment can be recorded and displayed in a time graph, evaluated and exported
- Realisation and analysis of intelligent power grids ("smart grid")
- Automatic busbar change

The Entire System at a Glance

Protection of power engineering facilities

SCADA

EGP

Generator protection

- Generator-differential protection
- Overcurrent time protection
- Unbalanced load protection
- Reverse-power protection
- Over/undervoltage protection
- Stator-earth fault protection
- Rotor-earth fault protection

SCADA

ETP

Transformer protection

- Transformer-differential protection
- Time overcurrent protection

Investigations on power engineering facilities

SCADA

EUG

Power generation

- Three-phase synchronous generators
- Synchronisation circuits
- Automatic power factor and power control

Renewable power generation

- Wind power
- Photovoltaics
- Fuel cells



SCADA

EUT

Transformers

- Transformer operating at no-load and with short circuit
- Transformer with ohmic, inductive and capacitive load
- Parallel operation of transformers
- Current distribution for various vector groups



Fundamentals of electrical engineering

Basics of electrical engineering

- DC technology
- AC technology
- Three-phase technology
- Magnetism/electromagnetism
- Measurements with the multimeter



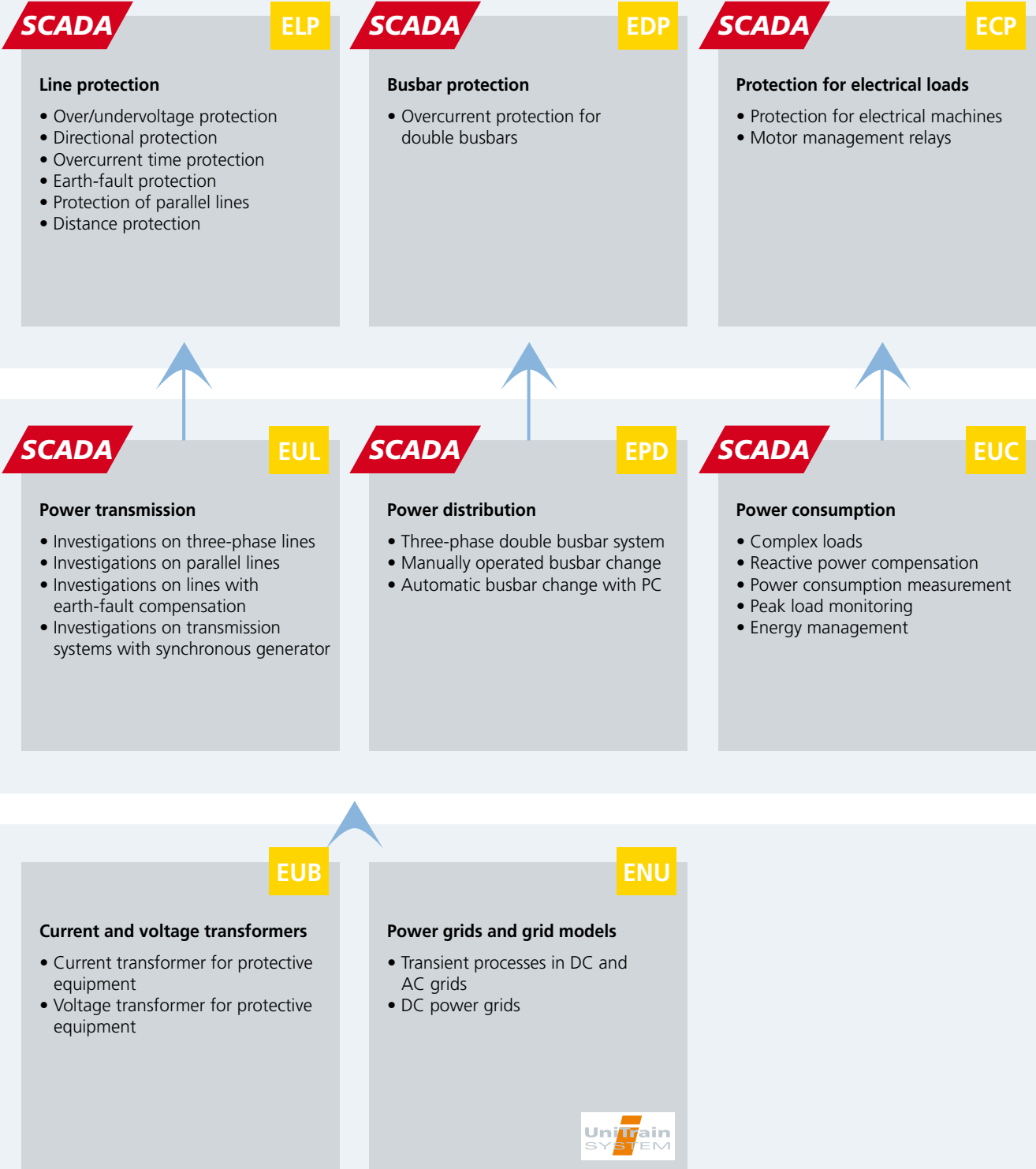

More Than Just a Training System

The Power Engineering Lab is a Complete Solution

Modern training media are used to graphically present complex learning material

Renewable energies:
Wind power, fuel cells, photovoltaics



"Smart grid": monitor, measure and control the entire power flow using the SCADA system

SCADA



Complete solutions for electrical power engineering: from power generation, transmission and distribution through to consumption – it's all covered.

Multimedia-based transfer of know-how using UniTrain-I



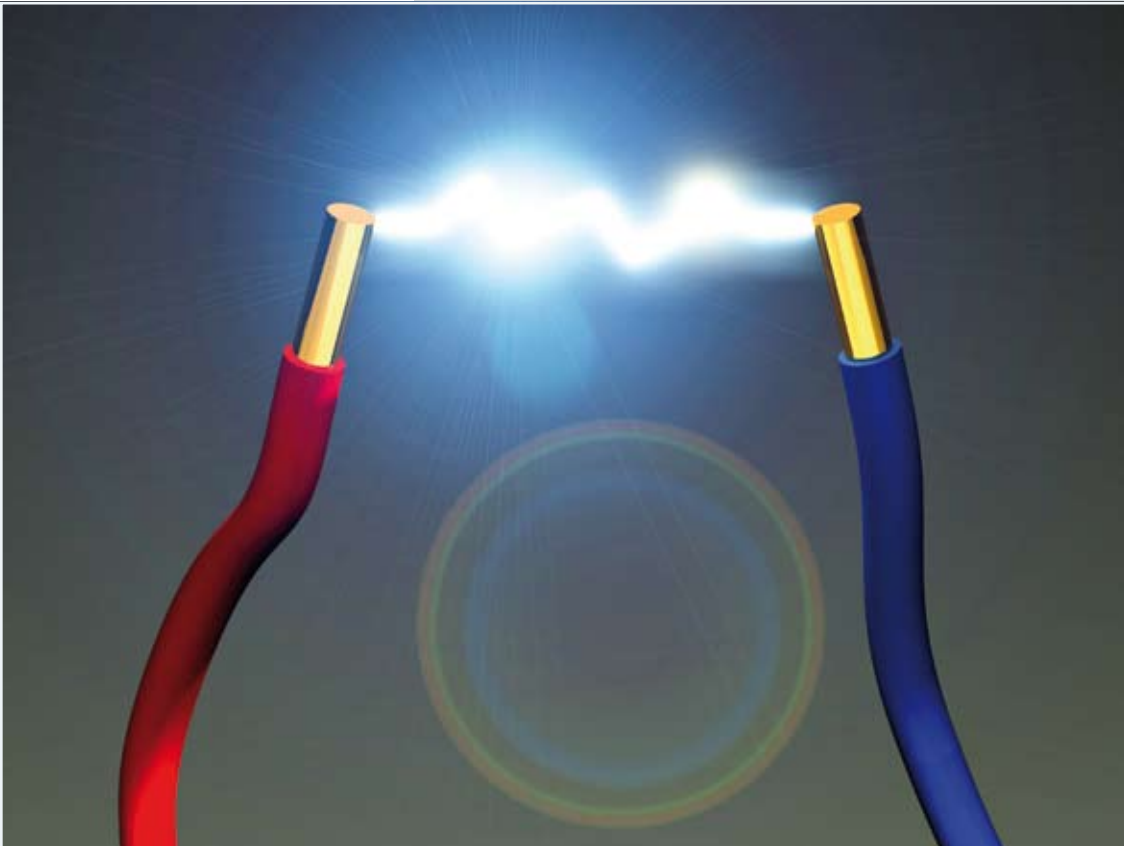

Fundamentals of Power Engineering

DC Technology (UniTrain-I)	20
AC Technology (UniTrain-I)	21
Three-phase Technology (UniTrain-I)	22
Magnetism/Electromagnetism (UniTrain-I)	23
Measurements with the Multimeter (UniTrain-I)	24
Power Grids and Grid Models (UniTrain-I)	25
Current and Voltage Transformers	26



Fundamentals of Power Engineering

Multimedia-based and Practice-oriented Introduction to Power Engineering

Using the multimedia-based experiment and training system UniTrain-I, the student is guided through experiments and theoretical sections accompanied by clearly structured course software which is enhanced by texts, graphics, animations and progress tests. In addition to the learning software, the course comes with a set of experiment cards on which practical assignments are performed.

With the aid of numerous experiments and animations, the UniTrain-I multimedia course gives the student insight into the latest important issues relating to power engineering. The fundamentals of DC, AC and three-phase technology as well as processes in distribution networks are some of the subjects dealt with in the various courses. Typical processes that occur in the generation and distribution of electrical power receive particularly close attention and are reproduced in the experiments using safe extra-low voltages.



Your benefits

- System trains theory and practice at same time and location
- Student motivation boosted thanks to PC and new media
- Structured course design leads to rapid learning success
- Quick understanding achieved through animation-backed theory
- Hands-on practical skill through autonomous experimenting
- Continuous feedback provided by comprehension questions and tests
- Guided fault finding using integrated fault simulator
- Safe due to the use of protective extra-low voltage
- Very wide selection of courses
- Sample solutions for the instructor

UniTrain-I system

- Comprehensive, portable laboratory
- Multimedia-based courses
- High-tech measurement and control interface
- Trains theory and practice at same time and location



Integrated meters and power supply units

- Multimeter, ammeter, voltmeter
- 2-channel storage oscilloscope
- Function and signal generator
- Three-fold power supply unit for AC and DC
- Three-phase power supply unit
- ... and many more instruments

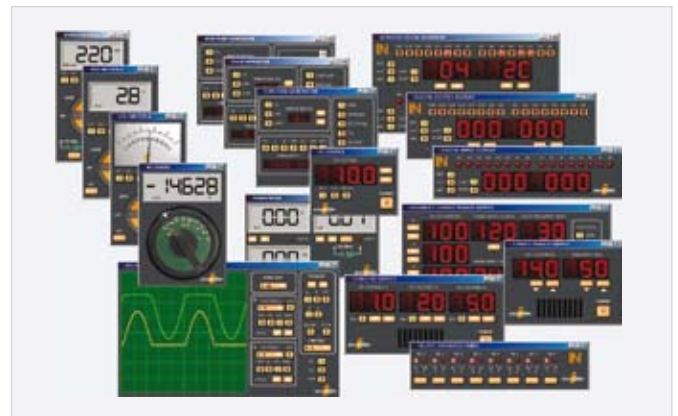

LabSoft learning and experimenting software

- Wide selection of courses
- Comprehensive background theory
- Animations
- Interactive experiments with instruction guide
- Free navigation
- Documentation of measurement results
- Tests available in the language of your choice

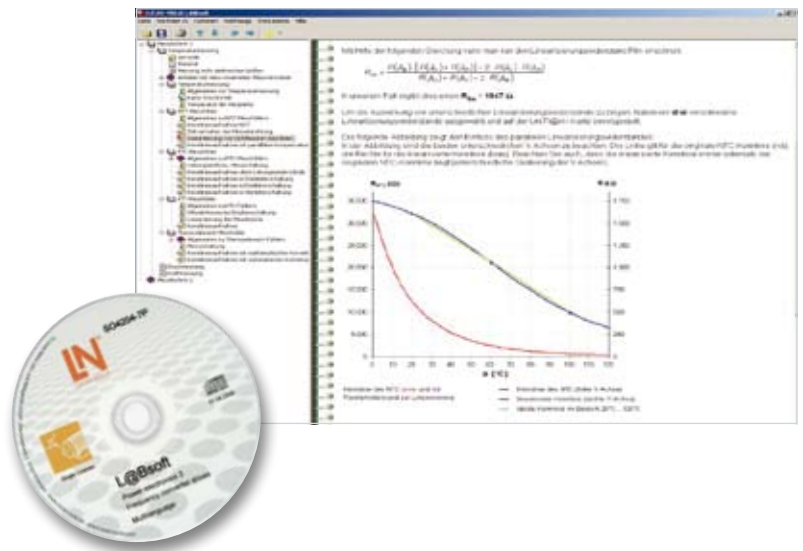

DC Technology

Current, Voltage and Resistance Circuitry

Current, voltage, resistance – learning the hands-on, practical side of the fundamentals of electrical engineering. This colourful course covers the basic laws of electrical engineering which are explored in numerous and easily understood experiments, animations and texts.



UniTrain
SYSTEM

Training contents

- Basic concepts: electrical charge, electrical field, current, voltage, resistance and power
- How to work with power sources and measuring instruments
- Experiment-based verification of Ohm's and Kirchoff's laws
- Measurements on series and parallel circuits as well as voltage dividers
- Recording the characteristics of variable resistors (LDR, NTC, PTC, VDR)
- Investigating the coil and capacitor inside a DC circuit
- Troubleshooting

AC Technology

Inductance, Capacitance, Oscillating Circuit/Transformer

How do coils and capacitors respond when an AC current is applied? What is an oscillating circuit and how does a transformer work?



UniTrain
SYSTEM

Training contents

- Parameters of periodic and sinusoidal signals
- How to work with vector diagrams
- Determine reactance of coils and capacitors using experiments
- How to explain active, reactive and apparent power
- Determine the frequency response of simple filter circuits
- Electrical oscillating circuit: resonance, quality, bandwidth and cut-off frequency
- Measurement of the frequency response of series and parallel resonant circuits
- Load, no-load and short-circuit measurements
- Frequency response of transformers and transducers
- Troubleshooting

Three-phase Technology

Star-delta Circuit Configuration, Three-phase Generator

Three-phase systems are of critical importance in power engineering and drive technology, both in terms of generation and the transmission of electrical power as well as the operation of high-powered industrial machinery.



UniTrain
SYSTEM

Training contents

- Measurements of phase-to-phase and line-to-line variables in the three-phase mains
- Experiment-based determination of laws between line-to-line and phase-to-phase voltages
- Ohmic and capacitive loads in star and delta circuit configuration
- Phase-shift between line and phase voltage
- Measurement of the compensation currents in the neutral conductor
- Effects of breaks in the neutral conductor
- Current and voltage measurements of balanced and unbalanced loads
- Power measurement at a three-phase load

Magnetism / Electromagnetism

Magnetic field, induction, components

Magnetism and electricity are very closely related. Many components in electrical engineering take advantage of electromagnetic effects.



UniTrain
SYSTEM

Training contents

- Magnetism: magnetic poles, magnetic field, field lines and field intensity
- Hard and soft magnetic materials, hysteresis
- Investigation of the magnetic field of a current carrying conductor
- Investigation of the magnetic field of an inductor (air-core coil, coil with core)
- Electromagnetic induction and Lorentz force
- Design and operation of a transformer
- Investigation of a transformer operating under various loads
- Design and function of electromagnetic components: relays, reed switches, Hall-type switches
- Investigation of application circuits

Measurements with the Multimeter

Current Measurement, Voltage Measurement, Resistors and Diodes

Taking measurements correctly and working safely – in this course, training involves how to work safely with a conventional multimeter on the basis of numerous measurement exercises and animations.



UniTrain
SYSTEM

Training contents

- Familiarisation with the operating elements of the multimeter
- Potential risks when measuring electrical circuits
- Measuring electrical DC and AC voltages with the multimeter
- Measuring electrical DC and AC currents with the multimeter
- Measuring resistors and diodes
- Zero balance and continuity testing
- Measurement range adjustment
- Identification of potential fault sources during measurements
- Determination of components in an unspecified circuit using current and voltage measurements

Power Grids and Grid Models

Transient Processes in DC and AC Power Grids

Networks or grids used in the distribution of electrical power consist structurally of transmission lines connected in parallel or serial configuration. In existing low-, medium- and high-voltage grids, there are two different processes that arise: stationary (constant loads) and transient phenomena. Transient processes arise due to short circuits or other faults.

Switching operations can also lead to transient processes under certain circumstances. These typical processes, which require special consideration during the generation and distribution of electrical power, are simulated and dealt with in experiments run with protective extra-low voltages.



UniTrain
SYSTEM

Training contents

- Learning about the significance of switching processes in power grids
- Listing the effects (hazards) of switching processes in power grids
- Experiment-based investigation of the current and voltage characteristics in response to switching on a DC voltage
- Investigation of the influence of various loads (R, L, C) on the signal characteristic
- Experiment-based investigation of the current and voltage characteristics in response to switching on an AC voltage
- Investigation of the influence of the on and off switching time
- Signal characteristic measurements at various switch-off times
- Determination of the optimum switching time
- Analysis of on and off switching processes and their effects on complex loads (R, L, C) at different switching times

Current and Voltage Transformers

Current Transformer for Protective Equipment

A wide spectrum of current and voltage transformers are used for various requirements in electrical power engineering. The experiments include a practical hands-on investigation of transfer response, over-current factor, absolute and phase angle error, as, for example, under varying loads. In addition to this, standard operation requirements, short-circuit and asymmetrical faults can also be explored.



Sample experiment "Current transformer" EUB 1

Training contents

- Secondary transformer current as a function of the primary current
- Effect of the load on current ratio error
- Check rated overcurrent factor
- Transformer circuit in three-wire system
- Transformer circuit in four-wire system
- Determine zero residual current

Voltage Transformer for Protective Equipment

The protection of system facilities and components is not only dependent on selective protection equipment but also on the detection and measurement of the lowest fault currents and voltages. Various types of measurement circuits have to be used for different star-point circuit configurations in order to correctly detect and localise potential fault types.



Sample experiment "Voltage transformer" EUB 2

Training contents

- Voltage transformer characteristics
- Calculation of voltage faults and class of accuracy
- Effect of loads on the transformation ratio
- Three-phase voltage transformer in a healthy grid
- Three-phase voltage transformer in a grid with earth-fault on the primary side



Source: Woodward SEG

Power Generation

Synchronous Machines (UniTrain-I)	32
Automatic Generator Control and Synchronisation	33
Generator Protection	35



Power Generation

Three-phase synchronous generators

In addition to the basic experiments on three-phase synchronous generators, the experiments in this area also cover manually-operated and automatic synchronisation circuits as well as automatic power factor control ($\cos\phi$ control) and power control. For that reason, this module can be used to simulate both on-grid and off-grid power plant operation. Furthermore, generators need effective protection against internal and external faults. The deployment of a variety of protective equipment is a prerequisite for this.



Three-phase synchronous generators

Electrical power is primarily generated using three-phase generators. This applies to both power stations as well as power generating units and wind generators.

These generators must be protected against internal and external faults using a wide range of protective devices.



Source: Woodward SEG

Servo machine test bench

An essential component of power engineering equipment sets is the servo machine test bench – a complete testing system designed for the examination of electrical machines and generators. It consists of the digital control unit, a servo drive and the ActiveServo software package. The system combines state-of-the-art technology with simple operation. In addition to the drive and brake, working machine models can also be emulated realistically. As such, machines, generators and drives can be investigated under industrial-like conditions inside the laboratory.



Training systems

Our training systems cover the following topic areas:

- UniTrain-I three-phase synchronous generators
- “Automatic generator control and synchronisation” training panel system
- “Generator protection” training panel system



Synchronous Machines

Slip-ring Rotor Machine, Synchronous Machine, Reluctance Machine

Reluctance motors are the motors of the future. Today, three-phase machines with synchronous and slip-ring rotors are already in widespread use.



UniTrain
SYSTEM

Training contents

- Explanation of the technology and its practical applications
- Exploration of the basic physics needed to understand the technology
- Starting machines with start resistors as well as variable frequency
- Open-loop speed control
- Conduct various experiments on:
 - Connection of motors with slip-ring rotors
 - Influence of open or wired rotor windings
 - Effect of different exciter voltages

Automatic Generator Control and Synchronisation

Manually operated Synchronising Circuits

Electrical power is primarily generated by three-phase generators. This applies both for power stations as well as power and wind generators. In addition to performing basic experiments on the three-phase synchronous generator, other experiments cover the topic of manually operated synchronising circuits.



Sample experiment "Manually operated synchronising circuits" EUG 1

Training contents

- "Dark" synchronising circuit
- "Light" synchronising circuit
- "Cyclic" synchronising circuit
- Active power generation
- Inductive reactive power generation
- Capacitive reactive power generation

Automatic Generator Control and Synchronisation

Automatic synchronising circuits, automatic power control and power factor control

Besides the experiments on automatic synchronisation circuits, there are also experiments included on automatic power factor (cos-phi) and power regulation. Consequently, a power station can be simulated in off-grid and on-grid operation.

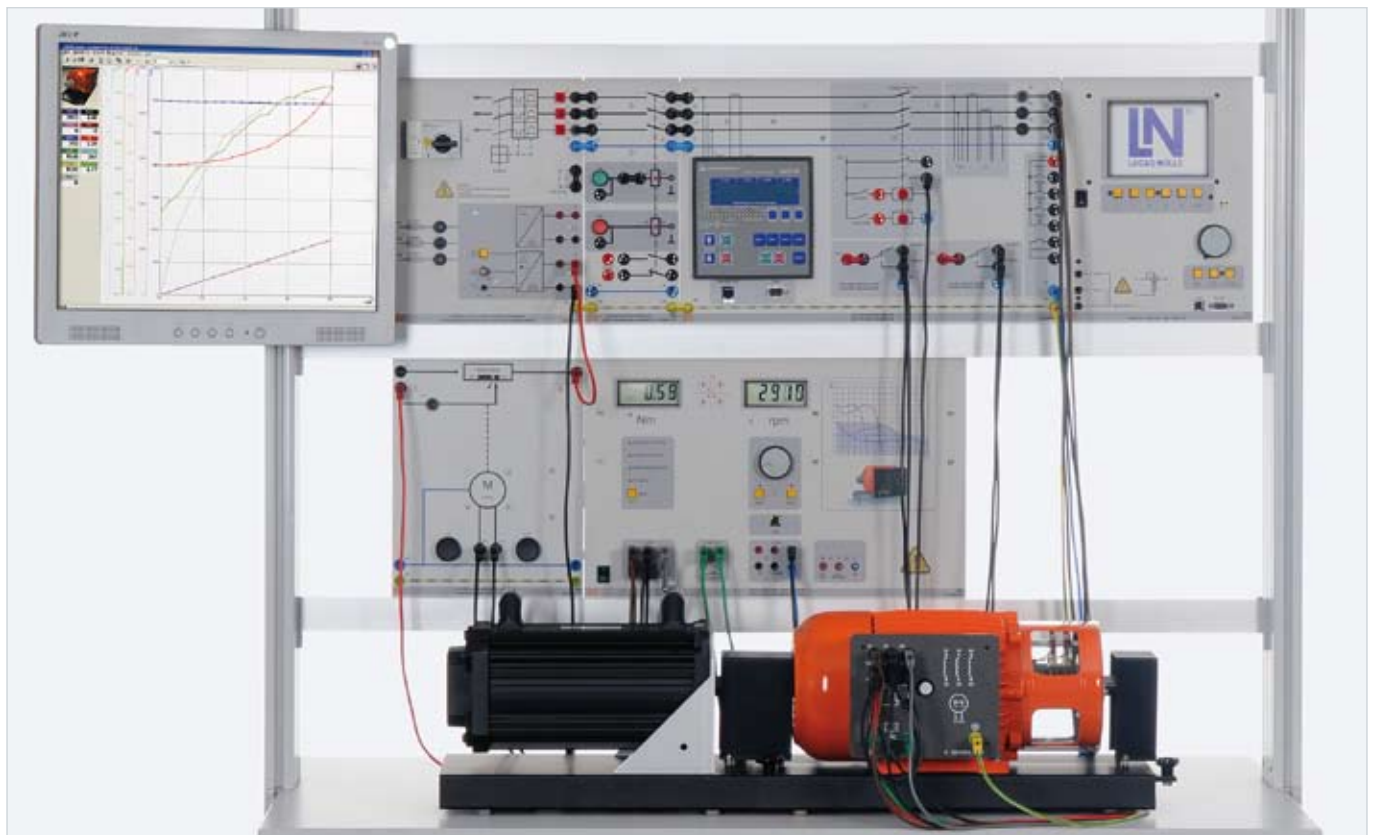

Sample experiment "Automatic synchronising circuits" EUG 2

Training contents

Automatic synchroniser circuits

- Putting into operation and parameterisation of the automation unit
- Synchronisation in test mode
- Synchronisation to the real power grid
- Response of the automation unit to faulty programming

Automatic power factor control

- Parameterisation of the automatic cos-phi controller
- Synchronisation of the generator to the power grid
- Cos-phi control of the synchronous generator
- Cos-phi control of the power grid

Automatic power control

- Parameterisation of the automatic power controller
- Synchronisation of the generator to the power grid
- Response of power controller to change in control variable and disturbance variable
- Power controller sensitivity and direction of action

Generator Protection

Multifunction Relays

Effective protection of generators against internal and external faults requires that a wide variety of protective devices be deployed. The time overcurrent protection constitutes the reserve protection for the generator and can also be used for the detection of external faults, such as short circuits and overload, for example. Earth-fault occurrences are detected with the stator-earth fault protection. The investigation of reverse power and unbalanced load protection as well as overvoltage/undervoltage protection concludes the experiment series titled "EGP" on generator protection.



Sample experiment "Generator protection" EGP 1

Training contents

Time overcurrent protection

- Operating response and release response for single-pole and three-pole faults
- Determining the tripping times

Unbalanced load protection

- Operating and release response to unbalanced load
- Determining the reset ratio and the tripping times
- Determining the relay characteristic $TA = f(\text{unbalance})$

Reverse power protection

- Synchronisation of the generator to the power grid

- Detection and disabling of the generator in the case of reverse power flow

Overvoltage and undervoltage protection

- Reactions to phase failure
- Detection of starting and tripping times

Stator-earth fault protection

- Detection of system voltages under normal operating conditions or stator-earth fault occurrence
- Measurement of tripping times
- Calculation of the earth-fault current

Generator Protection

Generator Differential Protection

Generator differential protection which detects internal faults such as short-circuit, turn-to-turn and winding-to-frame shorts or double earth faults, serves as primary protection.

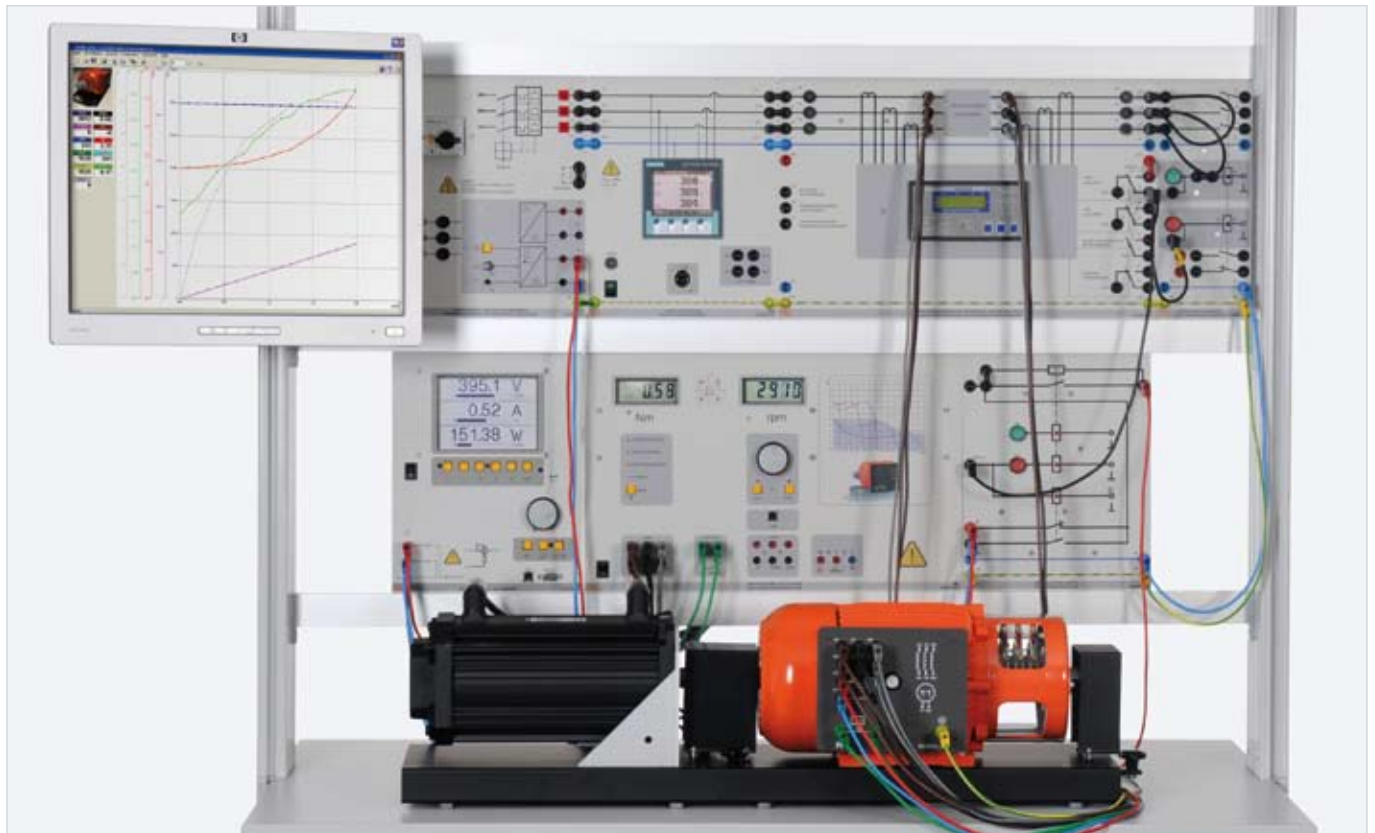

"Generator differential protection" EGP 2

Training contents

- Calculating protection operating values
- Fault recognition within the protection range
- Testing tripping and reset for faults occurring inside and outside the protection range
- Disconnection and de-excitation of the generator
- Measurement of the operating (pick-up) currents of the protection device for symmetrical and asymmetrical faults
- Comparison of measured values to set values

Rotor Earth-fault Protection

The rotor earth-fault protection is used to determine earth faults in the exciter circuit of synchronous machines.

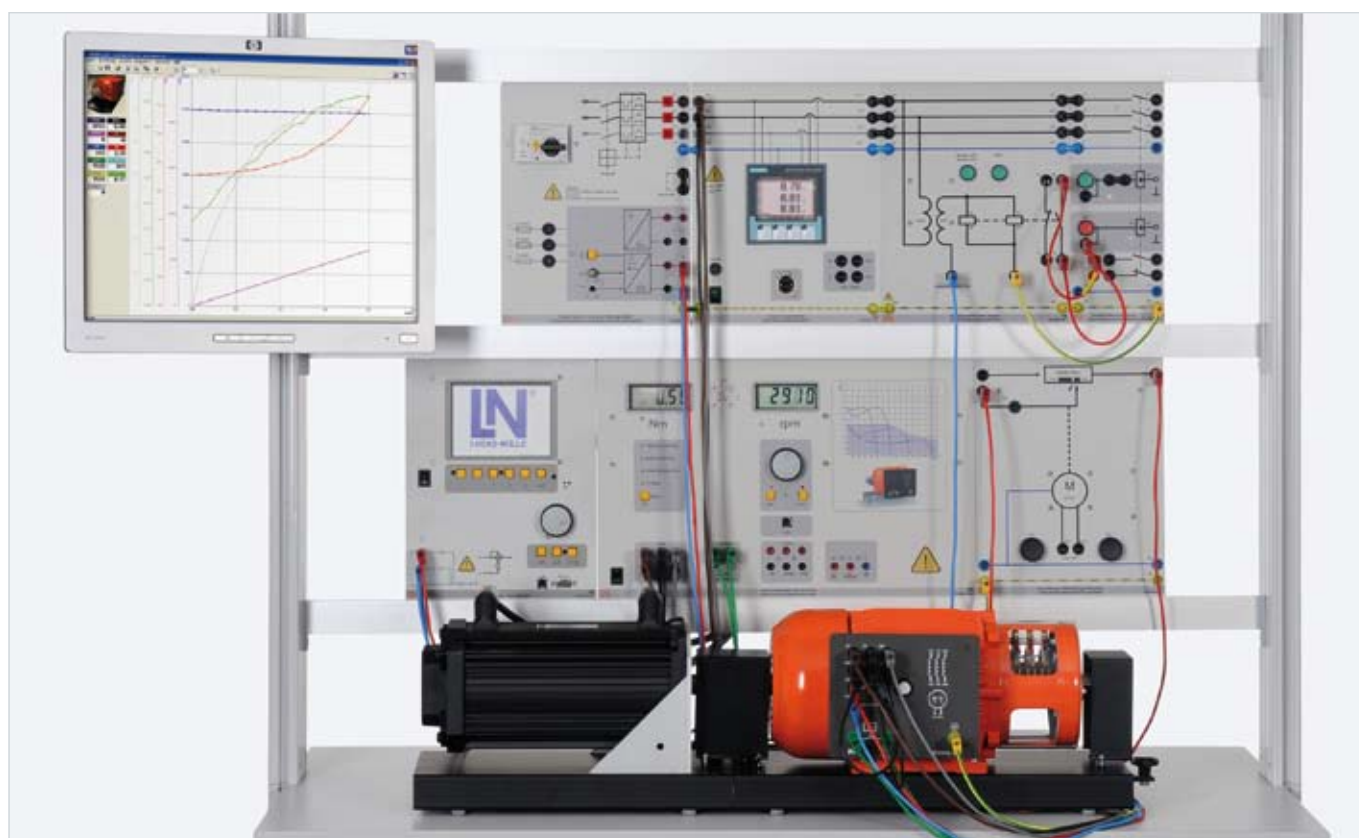

„Generator protection - rotor earth-fault protection“ EGP 3

Training contents

- Putting the synchronous generator into operation
- Investigation of normal operating conditions and rotor earth-fault occurrences
- Measurement of the rotor earth-fault current
- Rotor earth-fault relay during earth-fault operation:
 - Connection and testing of the earth-fault relay
 - Setting different rotor earth faults
 - Testing the fault signal and disconnection



Renewable Power Generation

Photovoltaics (UniTrain-I)	42
Advanced Photovoltaics	44
Wind Power Plants	48
Small Wind Power Plants	52
Fuel Cell Technology (UniTrain-I)	54
Advanced Fuel Cell Technology	56



Renewable Power Generation

Inexhaustible, Sustainable, Real – the Future is Green

The move away from coal, oil and nuclear power to renewable forms of energy is gaining momentum. Today, technology has evolved to a point where solar energy, wind power, hydrogen fuel and biomass can be exploited as environmentally friendly energy sources. In order to sustain this trend, the search is on to find and train well-qualified technical staff worldwide. Technologies are continuing to change rapidly, as are related requirements for training. Lucas-Nülle has the training systems to meet increasingly complex educational demands.



Sunny prospects with photovoltaics

- Abu Dhabi has announced it will invest about two billion US dollars in technology for manufacturing thin-film photovoltaic modules in Masdar.
- The USA's largest solar power plant with a rated output of 25 megawatts is being established in Silicon Valley.
- Photovoltaic facilities capable of generating a total of five gigawatts have already been realized in Germany. This output is equivalent to that of five modern power plant units. By 2020, photovoltaic power generation capacity is to be increased gradually to 40 GW.



A clean future with wind energy

- Forecast for Germany: By 2030, 25% of electricity will be produced by means of wind power.
- A 3.0-megawatt wind farm annually saves 13,000 barrels of oil or 10,000 tons of CO₂.



Fuel cells – Long term energy storage elements

- Used in zero-emission vehicles
- Used widely as a standby power source
- Used by co-generation units



Photovoltaics

Sunny prospects with the photovoltaics course

In times of soaring energy costs and increased environmental awareness, photovoltaic technology constitutes a very interesting alternative to traditional power generation. With the photovoltaics course, you can not only research the fundamentals of solar cells, but also simulate operation of a photovoltaic system in direct or storage mode.



UniTrain
SYSTEM

Training contents

- Functions and operating principles of solar cells
- Recording the characteristics of a solar module
- Dependency of a solar module's current and voltage on temperature, irradiance and angle of incidence
- Series, parallel and other types of circuit for solar cells
- Manufacture of solar cells
- Various types of solar cell
- Design of a rechargeable solar cell
- Various types of solar plant
- Setup of an off-grid power system with rechargeable solar cells

Multimedia course consolidates the experiment

What is a solar cell?

Structure of a PV cell

PV cells are semiconductors which become electrically conductive on exposure to light or heat.

The following animation shows the schematic layout of a PV cell

- Rear-side metal contact:**
The PV cell's voltage can be tapped via this contact
- p-semiconductor layer:**
Added to this semiconductor material are foreign atoms possessing fewer semiconductor. This is a p-type semiconductor layer
- n-semiconductor layer:**
Added to this semiconductor material are foreign atoms possessing more semiconductor. This is a n-type semiconductor layer
- Contact fingers:**
Together with the rear-side metal contact the contact fingers make up the
- Antireflective layer:**

The hot-spot phenomenon

If a PV module's entire surface is shaded evenly, the module's output power naturally decreases, but the module suffers no damage. However, problems arise if the module is shaded unevenly, however, e.g. if just one PV cell is covered.

This can be easily demonstrated by a simplified, equivalent circuit diagram of a PV cell. This diagram represents a current source and diode connected in parallel.

Because a covered PV cell theoretically produces no current, the current source in the equivalent circuit diagram vanishes, leaving just the diode. If connected in series with several PV cells making up a module, the covered cell's diode is switched to the reverse direction, so that the module's overall voltage can drop across this cell. If the overall voltage exceeds the diode's reverse voltage, the diode gets damaged. While this overall voltage remains below the diode's reverse voltage, the diode experiences a power loss causing the cell to heat up and potentially damage the module. This effect is termed hot spot.

Your benefits

- Theoretical knowledge and practical know-how are conveyed using the UniTrain-I multimedia course
- Complete equipment set including all relevant components
- PC-supported evaluation of measurement data
- System operates with 12 V
- System supports fault simulation

Advanced Photovoltaics



Project Work with Industrial Components

The training system permits realistic simulation of paths taken by the sun. Emulators make it possible to conduct practical experiments in the laboratory without the sun.

Permitting PC-supported evaluation of measurement data, the advanced photovoltaics multimedia course is designed to convey both theoretical information and practical know-how.



Sample experiment "Advanced photovoltaics" EPH 2

Training contents

Investigating solar modules

- Testing the optimum alignment of solar modules
- Recording the characteristics of solar modules
- Investigating response to partial shading
- Investigating how bypass diodes operate
- Learning about various types of wiring for solar modules

Setting up photovoltaic systems for off-grid operation

- Installing PV systems
- Setting up and testing an off-grid PV system in direct mode

- Setting up and testing an off-grid PV system in storage mode
- Setting up and testing an off-grid PV system for generating 230-V alternating voltage

Setting up photovoltaic systems for grid-parallel operation

- Installing, setting up and testing a PV system with network feed
- Measuring the energy produced by a PV system
- Determining a grid-connected inverter's efficiency
- Investigating a PV system's response to mains failure

Advanced Photovoltaics

A Little Sunshine for your Lab

Interactive Lab Assistant

- Step-by-step instructions in multimedia format
- Explanation of physical principles using easily comprehensible animations
- Quiz and assessment tools for testing progress made during the course
- PC-supported evaluation of measurement data
- Virtual measuring instruments can be started directly from the experiment manual

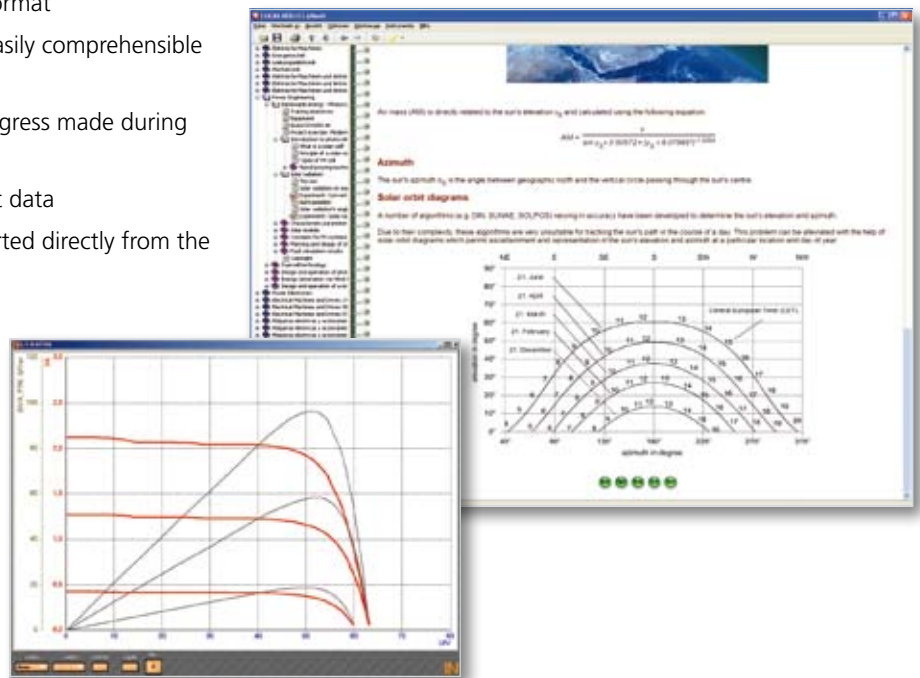

Solar module with altitude emulator

- The sun's angle can be adjusted as a function of position (latitude), date and time
- The solar module's inclination can be adjusted
- 10-W polycrystalline solar module
- 500-W halogen lamp with dimmer
- Realistic emulation of the sun's path



EPH 2 equipment set
Lucas-Nülle

Solar emulator

- Three independent solar emulators permit experiments even without sunlight
- Adjustable light intensity for each emulator
- Bypass diodes are included for connection into the circuits
- 120 VA power

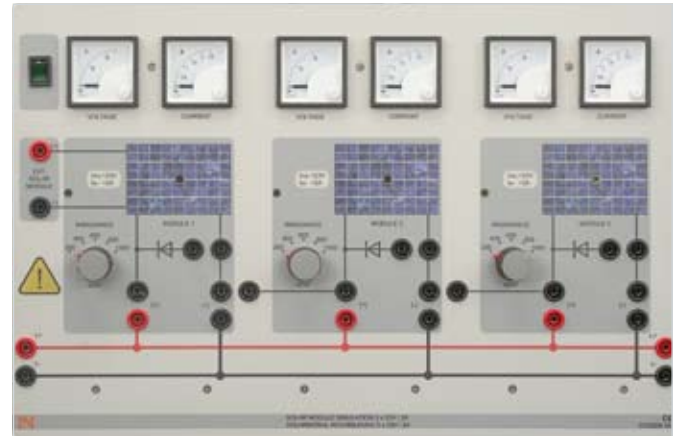

Industrial components

- Solar charge controller
- Off-grid inverter
- Grid-connected inverter
- Simple operation and investigation of industrial components



Your benefits

- Theoretical knowledge and practical know-how are conveyed using the Interactive Lab Assistant
- Use of industrial components
- Flexible experimentation by means of a real solar module or solar simulation model
- PC-supported evaluation of measurement data
- Integration into energy technology systems

Wind Power Plants



Double-fed Induction Generator (DFIG)

This equipment set is designed for investigating modern wind power plants incorporating double-fed induction generators. The wind can be emulated realistically by means of a servo machine test stand and "WindSim" software. A PC can be connected for convenient operation and visualization during the experiments. The associated multimedia course titled "Interactive Lab Assistant" imparts theory besides supporting experiment procedures and evaluation of measurement data.

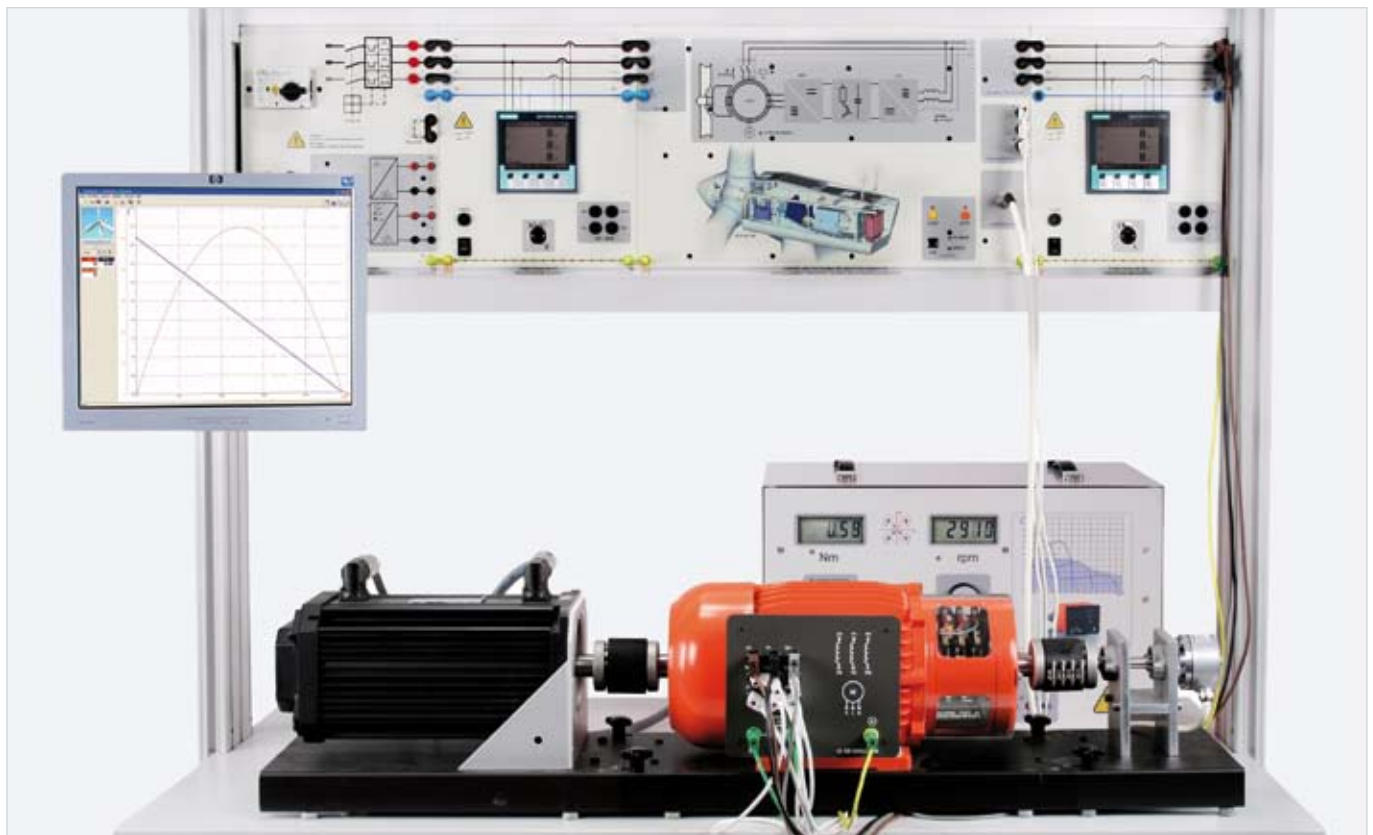

Sample experiment "Wind power plant" EWG 1

Training contents

- Understanding the design and operation of modern wind power plants
- Exploring physical fundamentals from "wind to shaft"
- Learning about different wind power plant concepts
- Setting up and operating a double-fed asynchronous wind generator
- Operating the generator at varying wind force levels as well as adjustable output voltages and frequencies
- Determining optimum operating points under changing wind conditions
- Investigating responses to "fault-ride-through" grid malfunctions

Wind Power Plants

Fresh Wind in the Laboratory

Interactive Lab Assistant

- Step-by-step instructions in multimedia format
- Explanation of physical principles using easily comprehensible animations
- Quiz and assessment tools for testing progress made during the course
- PC-supported evaluation of measurement data
- Virtual measuring instruments can be started directly from the experiment manual

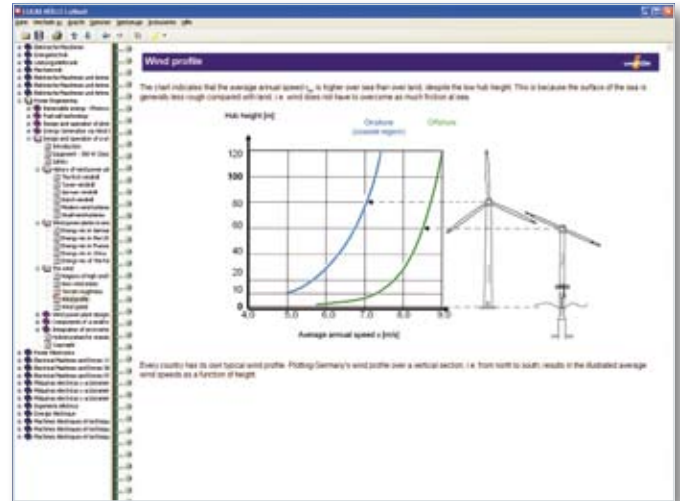

Wind emulator

Wind and airfoil geometry serve to drive the generators at a real wind power plant. In the laboratory, this task is performed instead with the help of a servo machine test stand and "Wind-Sim" software. This permits precise laboratory simulation of conditions prevailing at a real wind power plant.

- Realistic emulation of wind and airfoil geometry
- Speed and torque are matched automatically to wind strength and pitch
- Independently adjustable pitch and wind strength
- Wind profiles can be specified
- Mechanical and electrical variables can be recorded

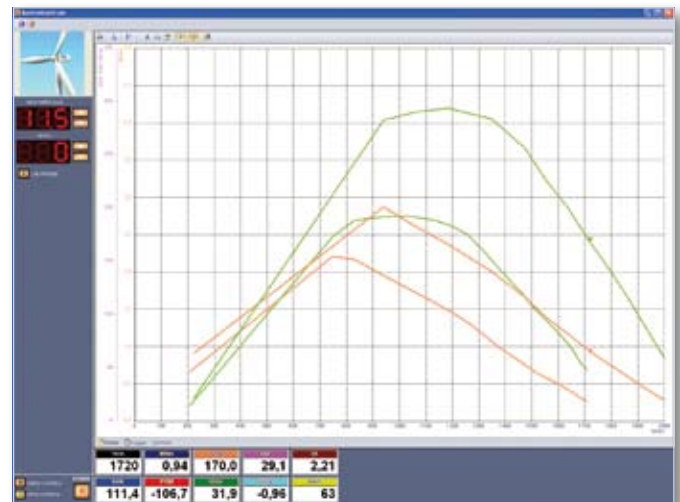

Double-fed induction generator with control unit

- Control unit with two controlled inverters
- Generator control in sub-synchronous and super-synchronous modes
- Integrated power switch for connecting the generator to the network
- Automatic control of active and apparent power, frequency and voltage
- Manual and automatic synchronization
- Measurement and display of all system variables
- Experiments on fault-ride-through

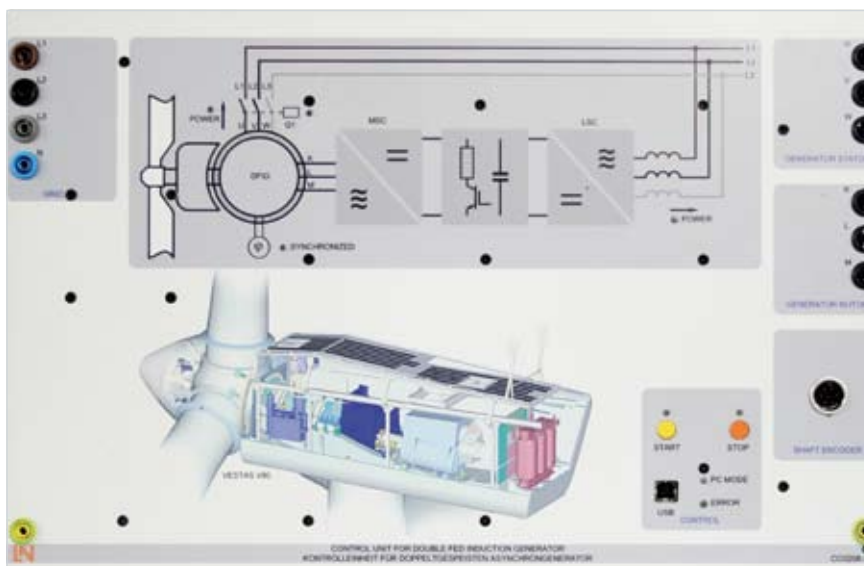

Your benefits

- Theoretical knowledge and practical know-how are conveyed using the Interactive Lab Assistant
- Wind power and mechanical design of wind power plants can be emulated accurately and in detail using the servo machine test stand
- The microcontroller-operated control unit for the double-fed induction generator permits user-friendly operation and visualisation during experimentation
- State-of-the-art technology incorporating "fault-ride-through"
- Integration into energy technology systems

Small Wind Power Plants

Decentralized Electricity Supply

Small wind power plants with outputs ranging up to 5 kW are deployed today for decentralized electricity supply. These plants generate direct voltages. The energy can be stored in batteries via charge controllers. Inverters produce alternating voltages to supply electrical consumers in the grid.

The effects of wind power and the mechanical design of wind power plants can be emulated down to the last detail using the servo machine test stand and the "WindSim software".



Sample experiment "Small wind power plant" EWG 2

Training contents

- Understanding the design and operation of small, modern wind power plants
- Exploring physical fundamentals from "wind to shaft"
- Learning about different wind power plant concepts
- Setting up and operating a small wind power generator
- Operation at varying wind forces in storage mode
- Energy storage
- System optimization
- Setting up an off-grid system for generating 230-V alternating voltage
- Investigating hybrid systems for autonomous power supply using wind power and photovoltaic systems

Convincing Product Characteristics

Interactive Lab Assistant

- Step-by-step instructions in multimedia format
- Explanation of physical principles using easily comprehensible animations
- Quiz and assessment tools for testing progress made during the course
- PC-supported evaluation of measurement data
- Virtual measuring instruments can be started directly from the experiment manual

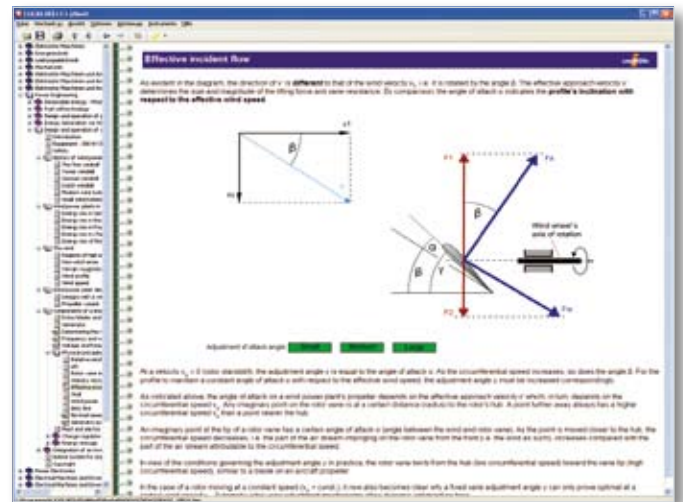

Synchronous generator

- Wind power and mechanical design of wind power plants can be emulated accurately and in detail using the servo machine test stand
- The laboratory generator's response is identical to that of one forming part of a real system
- The small wind power plant is suitable for outdoor operation



Your benefits

- Theoretical knowledge and practical know-how are conveyed using the Interactive Lab Assistant
- Wind power and mechanical design of wind power plants can be emulated accurately and in detail using the servo machine test stand
- The laboratory generator's response is identical to that of one forming part of a real system
- The realistic, small wind power plant is suitable for outdoor operation and includes an integrable mast set

Fuel Cell Technology

Design and Operation of Fuel Cells

Renewable energies are already considered a solution for dealing with expected energy shortages in the 21st century. The hydrogen-based fuel cell is part of this solution. As a complementary technology, it will be used in future energy systems to generate clean energy from renewable hydrogen.



UniTrain
SYSTEM

Training contents

- Functions and operating principles of fuel cells
- Recording the characteristics of a fuel cell
- Understanding the electrochemical processes of electrolysis (Faraday's first and second laws)
- Determining a fuel cell's Faraday and energy efficiencies
- Series and parallel connections of fuel cells
- Power aspects of fuel cells
- Functions and operating principles of electrolyzers
- Recording an electrolyser's UI-characteristic
- Determining an electrolyser's Faraday and energy efficiencies

Multimedia Course Consolidates the Experiment

Possible applications

Though its operating principle was discovered more than 150 years ago, it was only in the 1930s that the fuel cell was first employed in a technical application for space flight. The first experimental power plants arising in response to the energy crises of the 1970s and 80s did not prove long-lived. A number of additional applications have emerged since, and can be divided into three mobility classes.

Stationary applications

Stationary applications operate at a fixed location and cannot be transported. The advantage of this is supply of hydrogen via pipelines instead of cumbersome storage facilities on site.

A typical example is a combined heat and power plant, which not only supplies electrical energy, but also uses the thermal energy as a by-product to supply buildings with heat, for instance.

Mobile applications

These applications can move from one location to another, but are not compact enough to be carried around the portable equipment. Fuel cells of this class serve primarily to power electric drive motors. In this case, the hydrogen must be taken in mobile storage units which add to the degree of complexity.

Trucks, buses, submarines and trains can be powered by such applications. As an example, the Mercedes-Benz D-class passenger car is dealt with in some detail by this course.

Portable applications

Portable applications are small and light enough to be carried by people. This also gives for the storage units needed to continuously supply the fuel cells with hydrogen.

Applications here include standby power generators and power supply sources for mobile homes and cottages. Extremely compact fuel cells can also substitute batteries to power laptops and even cell-phones.

What are atoms?

It might seem a bit strange to ask this question for many years. However the only thing clear so far is the molecule size of an atom is made up of countless atoms and molecules. An atom can be imagined as a sphere with a diameter of about 0.1 nm.

Not visible even with the most powerful of microscopes. In the course of time however, scientists have been able to define characteristics of atoms. We will concentrate here on the atomic model developed by physicist Niels Bohr.

Atomic components

A **proton** is a positively charged particle which can be represented as a sphere of a certain mass. Although its mass is exceedingly small by human standards (1.67×10^{-27} kg), it decisively influences an atom's total weight. Protons are situated inside the atom's nucleus.

A **neutron** is also a spherical particle of the same size mass as a proton. In contrast to protons, however, neutrons have no charge. In other words, a neutron could be added to, or removed from, an atom without influencing its charge, though the atom's mass would increase or decrease by one unit as a result.

An **electron** is the exact opposite of a neutron. Furthermore, electrons are not situated inside the nucleus, but in orbits around it. Despite its negligible mass, the electron possesses a charge which is equal to that of a proton, but negative.

These components are always organized in the same pattern:

The orbitals are so fast that, when observed from outside, the atom appears to be enclosed in a shell. Accordingly, one also speaks of electron shells.

Your benefits

- Theoretical knowledge and practical know-how are conveyed using the Interactive Lab Assistant
- Compact device with PEM double fuel cell and PEM electrolyser including a gas storage element
- Safe handling of hydrogen
- 2V/2.5A for supplying power to the integrated electrolyser
- Diverse loads (lamps, fans)
- Variable load for recording characteristics

Advanced Fuel Cell Technology

Independent Electricity Supply with Fuel Cells

Generation of electrical energy using fuel cells continues to develop into a significant area with diverse potential applications in electrical and automotive engineering. Allowing safe handling of hydrogen and fuel cells, this experimentation system can be used for a number of interesting investigations and is suited for demonstrations as well as practical lab work. The "Interactive Lab Assistant" includes animated theory, experiment guidelines and result evaluation fields.



Sample experiment "50-VA fuel cell stack with loads" EHY 1

Training contents

- Design and operation of a fuel cell
- Design and operation of an electrolyser
- Design and operation of a metal hydride storage cell
- Fuel cell's thermodynamics
- Fuel cell's characteristic and power curve
- Efficiency
- Components needed for autonomous power supply
- Power electronics and voltage conversion

Interactive Lab Assistant

- Step-by-step instructions in multimedia format
- Explanation of physical principles using easily comprehensible animations
- Quiz and assessment tools for testing progress made during the course
- PC-supported evaluation of measurement data
- Virtual measuring instruments can be started directly from the experiment manual



Fuel cell stack

- 50-VA stack
- Hydrogen supply flow meter
- Variable-speed fan for fuel cell ventilation
- Measurement of all relevant variables

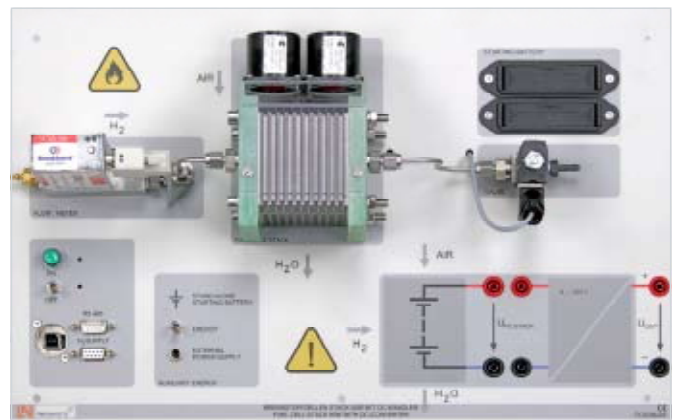

50-VA fuel cell stack

Your benefits

- Theoretical knowledge and practical know-how are conveyed using the "Interactive Lab Assistant"
- Simple introduction to the subject of fuel cells
- Safe experimentation with hydrogen
- 50-VA fuel cell stack
- Connection for pressurized hydrogen tank
- High-performance electrolyser
- Wide variety of loads
- Variable load for recording characteristics



Transformers

Three-phase Transformers (UniTrain-I)	62
Investigating Transformers	63
Transformer Protection	64

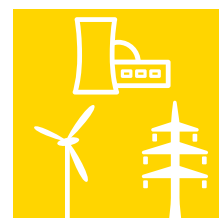

Transformers

Transforming and Protecting

In power engineering, transformers are used to connect the various voltage echelons of the power grid to each other. In transformer stations, electricity from the regional distribution grid with a medium voltage level of 10 to 36 kV is transformed to supply power to low-voltage end customers in the local grid where 400 V or 230 V is used. The heart of a transformer station is the transformer itself which also requires protective equipment. By carrying out hands-on measurements and fault simulations with the training system, it is possible to gain an understanding of these complex systems in the classroom.



Transformers

Transformers are electrical machines which serve to transform alternating or three-phase currents to higher or lower voltages. Three-phase transformers are of particular importance in the transmission of electrical power.

In power engineering, transformers are used to connect different voltage levels within the power grid to each other.



Source: SIEMENS

Transformer protection

Differential protection for transformers (starting from approx. 1 MVA), combined with time overcurrent protection, can be investigated using measurement techniques in normal operation, fault occurrences in various winding circuit configurations (star, delta), in various vector groups and as a function of star-point treatment (floating, direct or earthed using earth coils). In the case of differential currents, the tripping criteria is determined based on characteristic sensitivity.



Training systems

Our training systems cover the following topic areas:

- UniTrain-I "three-phase transformer"
- "Transformer investigations" training panel system
- "Transformer protection" training panel system

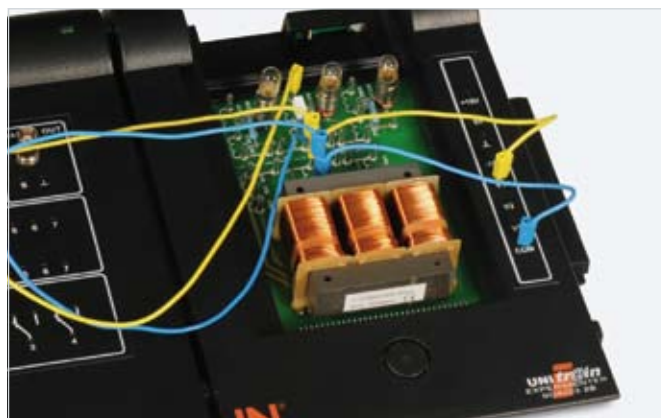

Three-phase Transformers

Models, Connection Types, Load Response

Transformers are electrical machines which serve to transform alternating or three-phase currents to higher or lower voltage levels. Three-phase transformers are of special importance in the transmission of electrical power.



UniTrain
SYSTEM

Training contents

- Learning about the transformer principle and equivalent circuit diagram
- Investigating the load response of single-phase transformers in single- and four-quadrant operation
- Recording current and voltage with and without loads
- Investigating the transformation ratio
- Investigating loads for different vector groups
- Investigating different vector groups in connection with unbalanced loads
- Determining the short-circuit voltage

Investigating Transformers

Transformers

In power engineering, transformers are used to connect different voltage levels of the power grid to each other. In the experiments, the transformer's equivalent circuit diagram is examined and its parameters are determined by means of measurements.



Sample experiment "Investigating transformers" EUT

Training contents

- Multiphase transformer operating at no-load and short-circuit
- Multiphase transformer with ohmic, inductive and capacitive load
- Parallel operation of multiphase transformers
- Current distribution for different vector groups
- Determining zero impedance
- Investigating the transformation ratio

Transformer Protection

Transformer Differential Protection

Differential protection for transformers (starting from approx. 1 MVA), combined with time overcurrent protection, can be investigated using measurement techniques in normal operation and fault occurrences in various winding circuit configurations (star, delta), and in various vector groups and as a function of star-point treatment (floating, direct or earthed using earth coils).

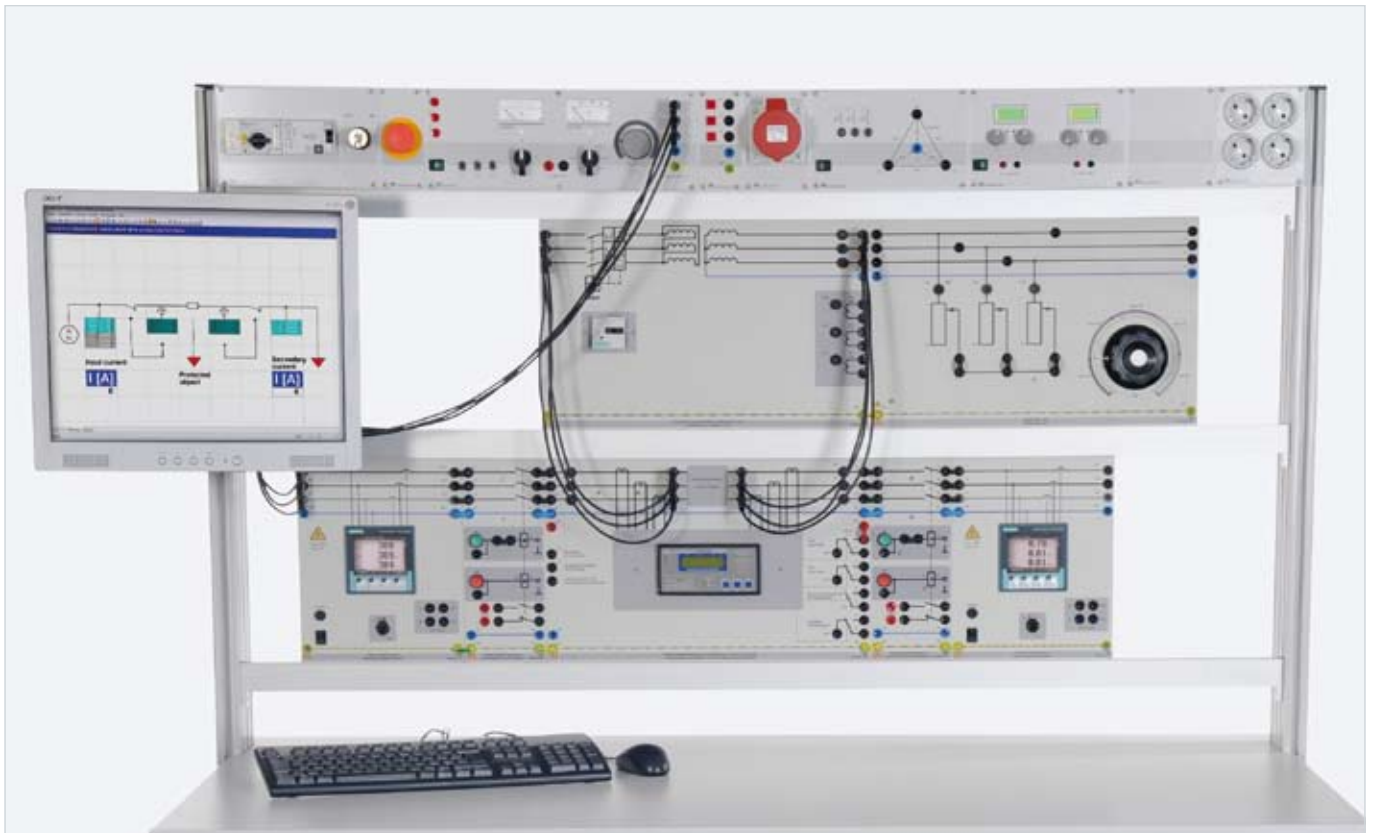

Sample experiment "Transformer differential protection" ETP 1

Training contents

- Detection and disconnection of transformer for internal faults
- Detection of peak inrush currents (RUSH) without disconnection
- Faulty tripping due to incorrectly dimensioned transformers
- Selection of tripping characteristics with differential currents taken into account

Time Overcurrent Protection

The time overcurrent protection supplements the safety protection measures contained in transformer differential protection. It protects the transformers against short circuits outside the protection range and against overloading.

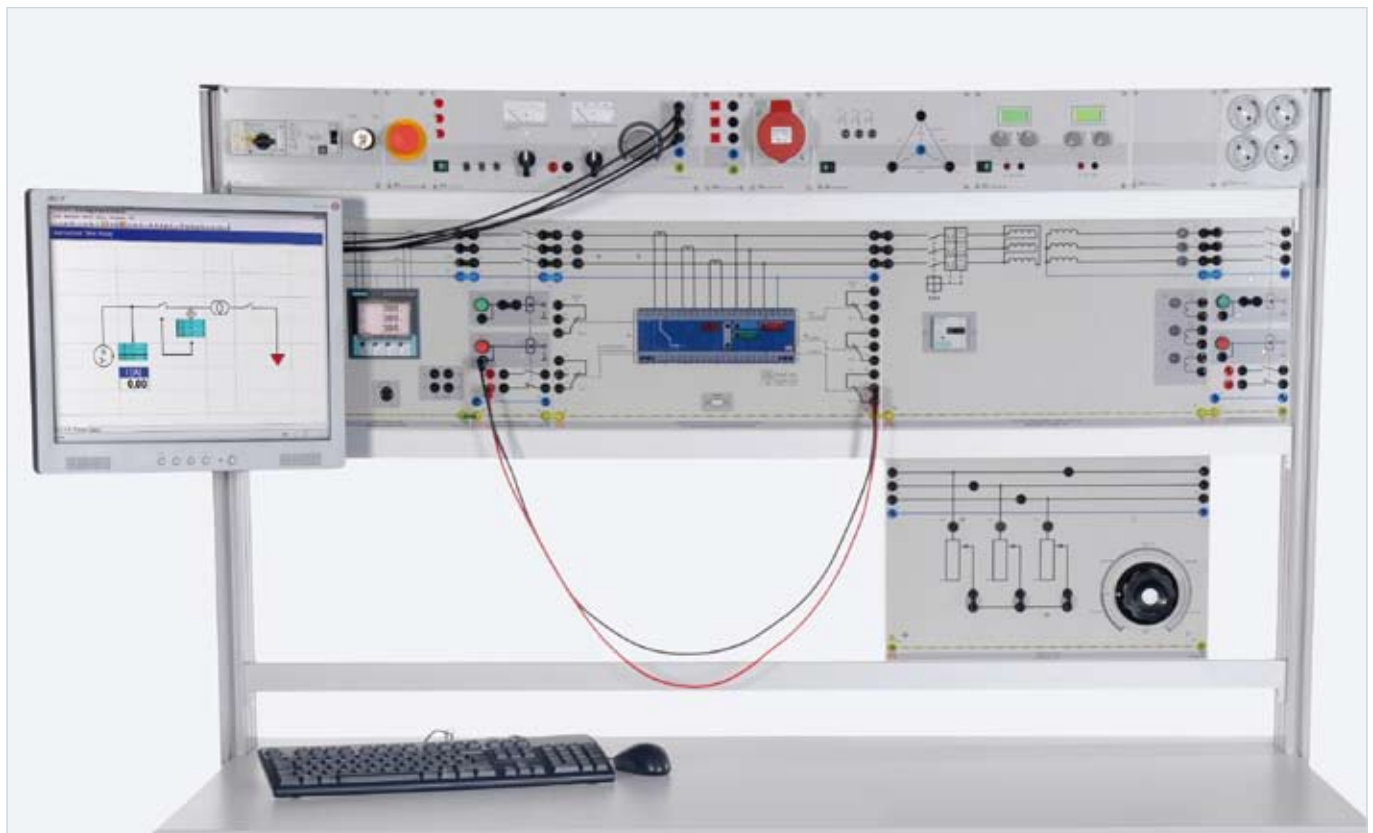

Sample experiment "Time overcurrent protection" ETP 2

Training contents

- Setting the parameters of the time overcurrent relay while taking the current transformation into consideration
- Detection of operating values for symmetrical and asymmetrical faults
- False tripping of the protective device during transformer's switch-on response
- Transformer switch-on response in terms of protection



Power Transmission

Investigation of Three-phase Transmission Lines	70
Parallel and Series Connection of Transmission Lines	71
Transmission Line with Earth-fault Compensation	72
Transmission Systems with a Synchronous Generator	73
Line Protection	74



Power Transmission

Transmission Lines and Measures to Protect Them

High-voltage networks are usually operated with voltages in the region of 110 kV to 380 kV, whereby urban areas and large-scale industrial facilities are supplied with 110 kV, and 380 kV is used for long-distance transmission lines. The line simulation system is designed for operation at model voltages between 110 V and 380 V. Various voltage levels and line lengths can be selected via corresponding overlay masks. Examinations with the training system can be performed off-load, in normal operating mode, in the presence of a short-circuit or earth fault, with or without earth-fault compensation. The system also permits assembly of complex networks by connecting the line simulation models in parallel or series. The voltage can be supplied via a fixed grid or synchronous generator.



High-voltage lines

Your benefits:

- For your safety, the 380-kV transmission lines are investigated and connected at a low-voltage level without detracting from the characteristics of a real high-voltage line.
- Realistic simulation of a 380-kV transmission line with a length of 300 km or 150 km
- Innovative switchover between line lengths by means of overlay masks
- Earth-fault compensation by means of a Petersen coil
- Ability to simulate symmetric and asymmetric faults



Innovative protection technology

In practice, medium-voltage and high-voltage networks are equipped with protective mechanisms connected via current and voltage transformers.

- Use of compact, original relays incorporating cutting-edge digital technology
- Use of industrial safety relays from prestigious international manufacturers
- Monitoring of protective features by means of SCADA (Supervisory Control and Data Acquisition)
- A relay test option permits the relays to be checked individually

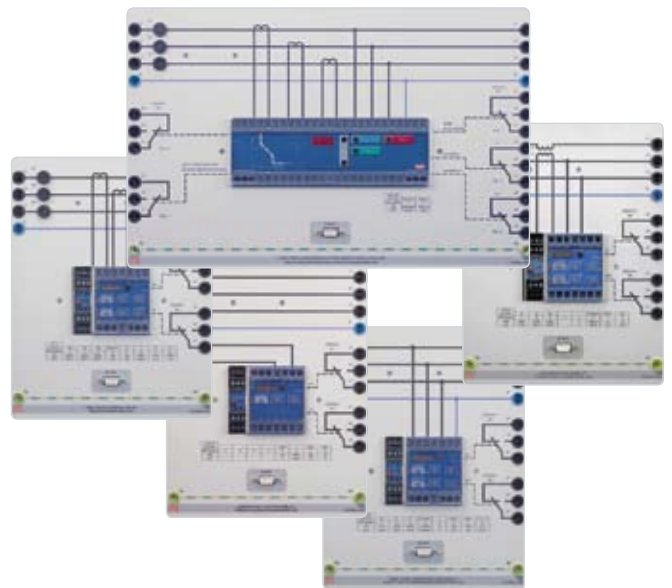

Training systems

Our training systems cover the following topics:

- Experiment panel group - "Transmission lines"
- Experiment panel group - "Line protection"

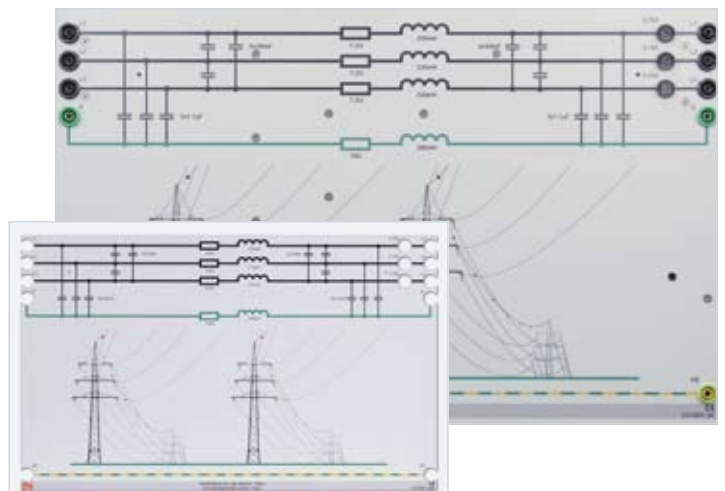

Transmission Lines

Investigations on Three-phase Transmission Lines

For your safety, the 380-kV transmission lines are investigated and connected at a low-voltage level without detracting from the characteristics of a real high-voltage line. This realistic simulation of a 380-kV transmission line switches over automatically between line lengths of 300 km and 150 km once the overlay mask has been put into place.

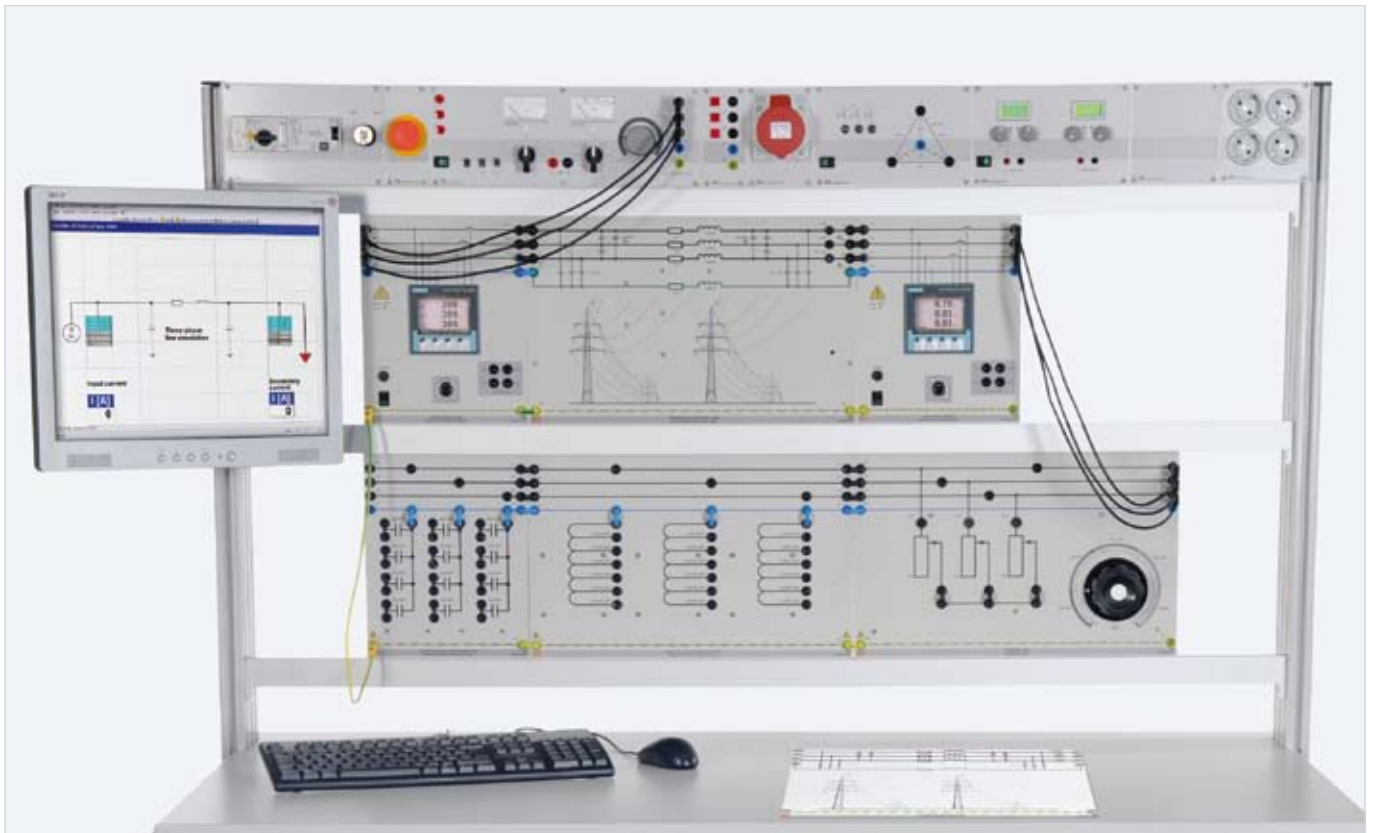

Sample experiment "Investigations on three-phase lines" EUL 1

Training contents

- Voltage increases on open-circuit lines
- Voltage drop as a function of line length
- Voltage drop as a function of $\cos\phi$
- Capacitive and inductive power losses on a line as a function of U and I
- Phase shift on a line

Parallel and Series Connection of Transmission Lines

Joint use of several line simulation models connected in parallel or series permits complex networks to be assembled.

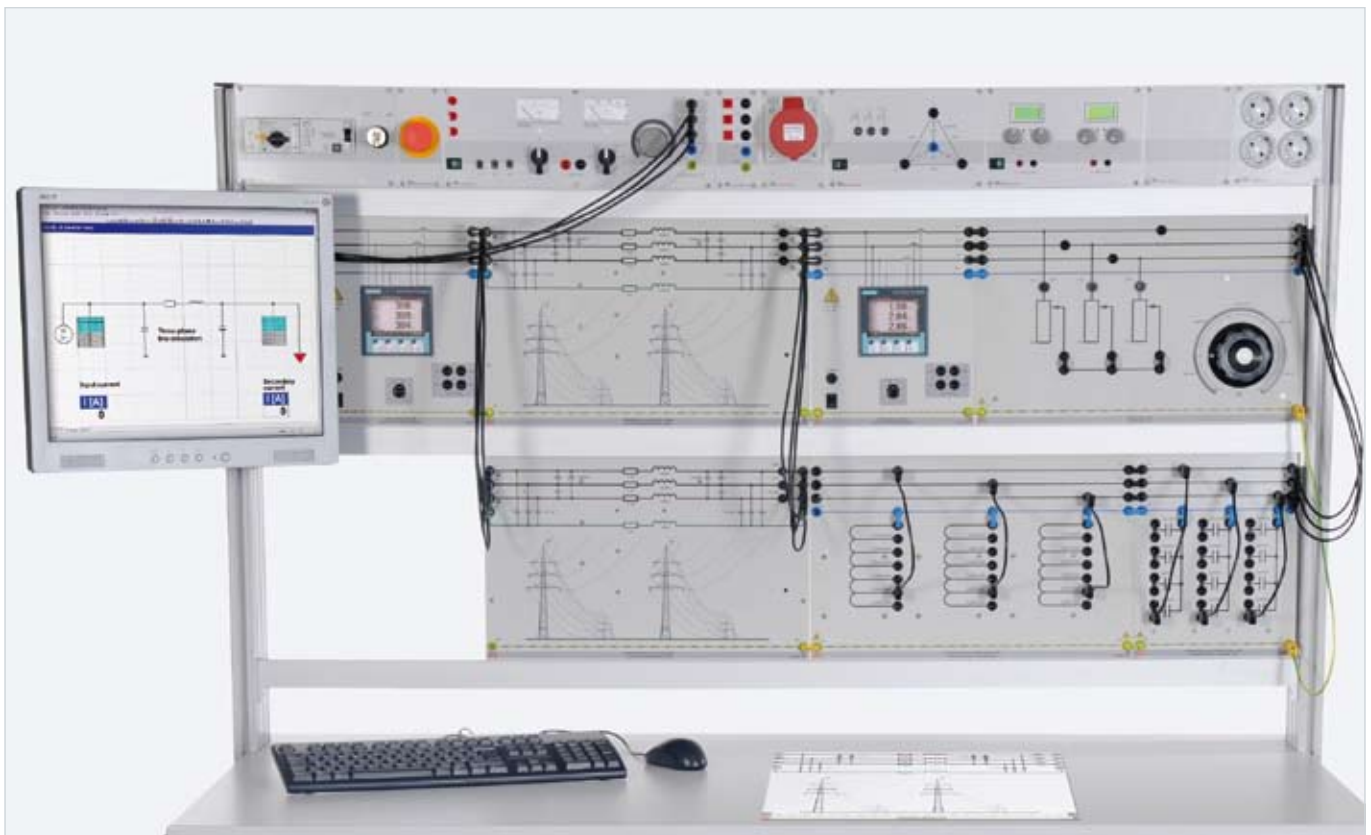

Sample experiment "Investigations on parallel lines" EUL 2

Training contents

- Distribution of power and current among parallel-connected lines of equal length
- Distribution of power and current among parallel-connected lines of unequal length
- Distribution of power and current among series-connected lines of equal length
- Distribution of power and current among series-connected lines of unequal length
- Load distribution, power flow
- Voltage distribution
- Quantitative and qualitative evaluations of operational relationships

Transmission Lines

Transmission Line with Earth-fault Compensation

Earth-fault compensation in electric power supply networks is designed to offset earth leakages occurring in outer conductors. Restricted to three-phase systems, earth-fault compensation makes use of a special Petersen coil named after its inventor and which is also known as an earth-fault quenching coil. This coil compensates the electric current at the earth-fault point, thereby preventing consequential malfunctions in the electrical system.



Sample experiment "Investigations on lines with earth-fault compensation" EUL 3

Training contents

- Earth fault on a line with an isolated star point
- Response to earth faults
- Earth-fault compensation

Transmission Systems with a Synchronous Generator

The objective here is to measure characteristic power transmission parameters on simulated, three-phase, parallel-connected lines fed via a fixed network or a generator, and perform quantitative as well as qualitative assessments of operational relationships.

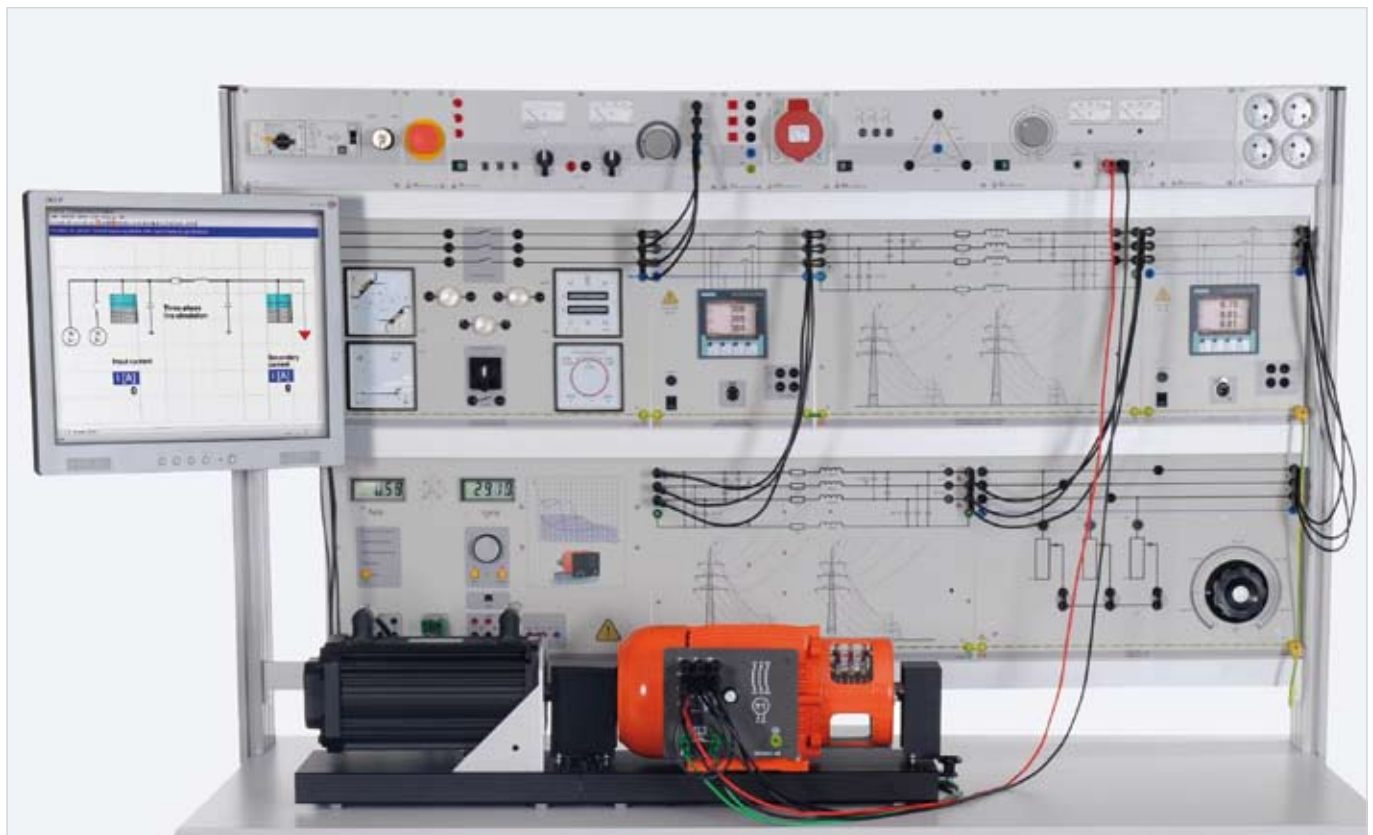

Sample experiment "Investigations on transmission systems with a synchronous generator" EUL 4

Training contents

- Power and current distribution in a line network fed by a generator
- Parallel operation of a generator and line via the network
- Control of active power feed
- Control of reactive power feed

Line Protection

Overcurrent Time Protection for Lines

Items covered in this experiment series include overcurrent time relays whose time characteristic is independent of the current and which are usually employed on single-wire (branch) lines.



Sample experiment "Overcurrent time protection for lines" ELP 1

Training contents

- Designing and parameterising overcurrent time protection
- Determining the reset ratio in the case of single-, double- and triple-pole short circuit
- Determining a relay's shortest release time
- Checking a circuit breaker's release behaviour in the event of a failure

Auxiliary Line Protection Equipment

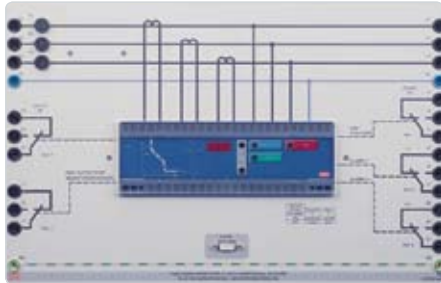

ELP 2 Directional overcurrent time protection

Training contents

- Designing and parametrizing overcurrent time protection
- Determining the reset ratio in the case of single-, double- and triple-pole short circuit
- Forward and reverse protection

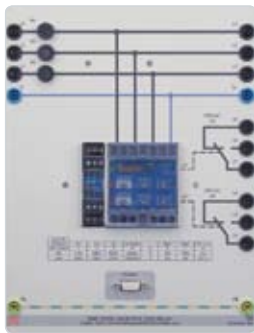

ELP 3 Overvoltage and undervoltage protection

Training contents

- Determining rise and fall times
- Determining the reset ratio
- Determining the inherent time
- Setting and testing various characteristics



ELP 4 Directional power protection

Training contents

- Determining rise and fall times
- Implementing protection against reverse loads
- Interaction with overcurrent time relays

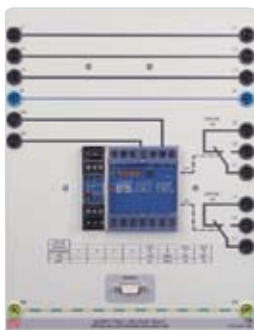

ELP 5 Earth-fault voltage protection

Training contents

- Measuring voltages in a sound, three-phase network
- Measuring voltages in a three-phase network experiencing earth faults
- Determining rise and fall times
- Determining the inherent time
- Relay responses to momentary and permanent earth faults

Line Protection

Protection of Parallel-connected Lines

Used mainly for protecting parallel-connected lines, the directional overcurrent protection relay is tested through fault simulation here, besides being analyzed and investigated experimentally in terms of selectivity and speed.

Networked via a bus system, the protective relays can be operated and evaluated by means of the SCADA Power-LAB software.



Sample experiment "Protection of parallel lines" ELP 6

Training contents

- Protecting parallel-connected lines with different overcurrent time relays
- Parallel operation in the fault-free state
- Determining minimum response values for non-directional overcurrent time relays
- Determining directions of protection for directional overcurrent time relays
- Determining minimum response values for directional overcurrent time relays
- Time grading for overcurrent time relays
- Checking selectivity through combined overcurrent and directional measurements
- Networking protective measures

High-speed Distance Protection

Various faults can be analyzed in the case of the high-speed distance protection relay employed for more complex networks. This type of protection permits faults to be isolated in dependence of their distance. Besides preparation of a grading schedule, selectivity can be set and tested in a practical manner.



Sample experiment "High-speed distance protection" ELP 7

Training contents

- Preparation of a grading schedule
- Relay parameterisation
- Tests of triggering characteristics in the event of various faults inside and outside the line's protective domain
- Operating a distance protection relay with current and voltage transformers
- Tests of triggering characteristics in the event of various faults inside and outside the protective domain:
 - Distance protection
 - Overcurrent time protection
 - Voltage protection
 - Frequency protection
- Automatic reactivation



Electric Power Distribution

Three-phase Double Busbar System	82
Overcurrent Protection for Busbars	83



Electric Power Distribution

Busbars at high-voltage switching stations

Electrical power at large switching stations is distributed almost exclusively using double busbar systems. These stations incorporate switching matrices for connecting the two busbars, the incoming and outgoing feeder cubicles as well as the measurement fields. The incoming and outgoing feeder cubicles as well as the switching matrices are furnished with circuit breakers and one disconnector for each busbar terminal. For safety reasons, a particular switching logic must be strictly adhered to here. The double busbar model incorporates all functions of practical relevance. Integrated instruments for measuring currents and voltages permit direct analyses of switching operations.



Double busbar systems

The compact modules named "Incoming and outgoing feeder cubicles" and "Switching matrix" offer the following advantages:

- Flexible arrangement of the various fields
- Operation and monitoring from a PC
- Networking capability thanks to an RS-485 interface
- Manual operation
- Integrated microcontroller for preventing incorrect operation
- Registration of all characteristic parameters such as current, voltage and switching states



SCADA

Devices are monitored and controlled by means of the SCADA (Supervisory Control and Data Acquisition) system. All devices belonging to Lucas-Nülle's energy technology programme can be arranged as desktop icons and linked together. Measurement values and operating states are indicated. Important parameters and signals can be controlled via the software. Measurement values and operating states can be recorded, displayed as functions of time, and analyzed. Automatic switchover between busbars can be performed via the PC.

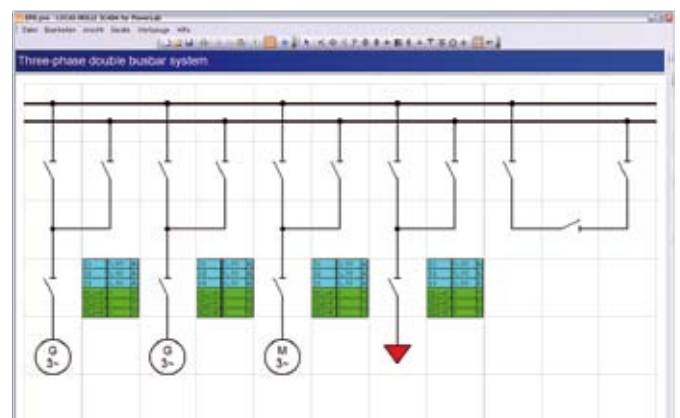

Training systems

Our training systems cover the following topics:

- Experiment panel group - "Three-phase double busbar system"
- Experiment panel group - "Overcurrent protection for busbars"

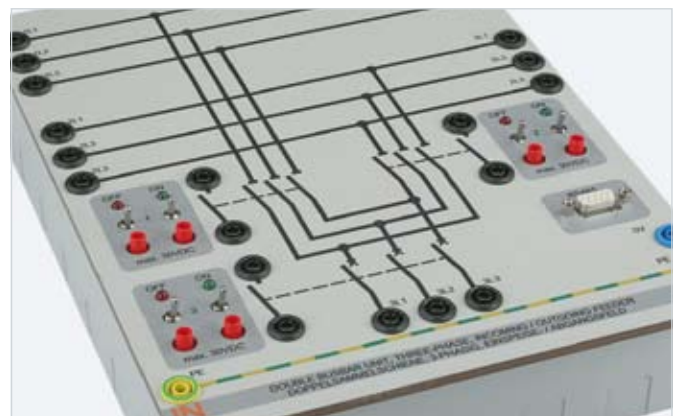

Three-phase Double Busbar System

Central Distribution and Control

Busbars serve as central distributors of electrical energy, all incoming and outgoing lines being connected to the busbars. Busbars comprise incoming and outgoing feeder cubicles, switching matrices and converter panels.

As part of Lucas-Nülle's equipment sets, these functions are grouped into switching fields containing circuit breakers, disconnectors and data loggers.

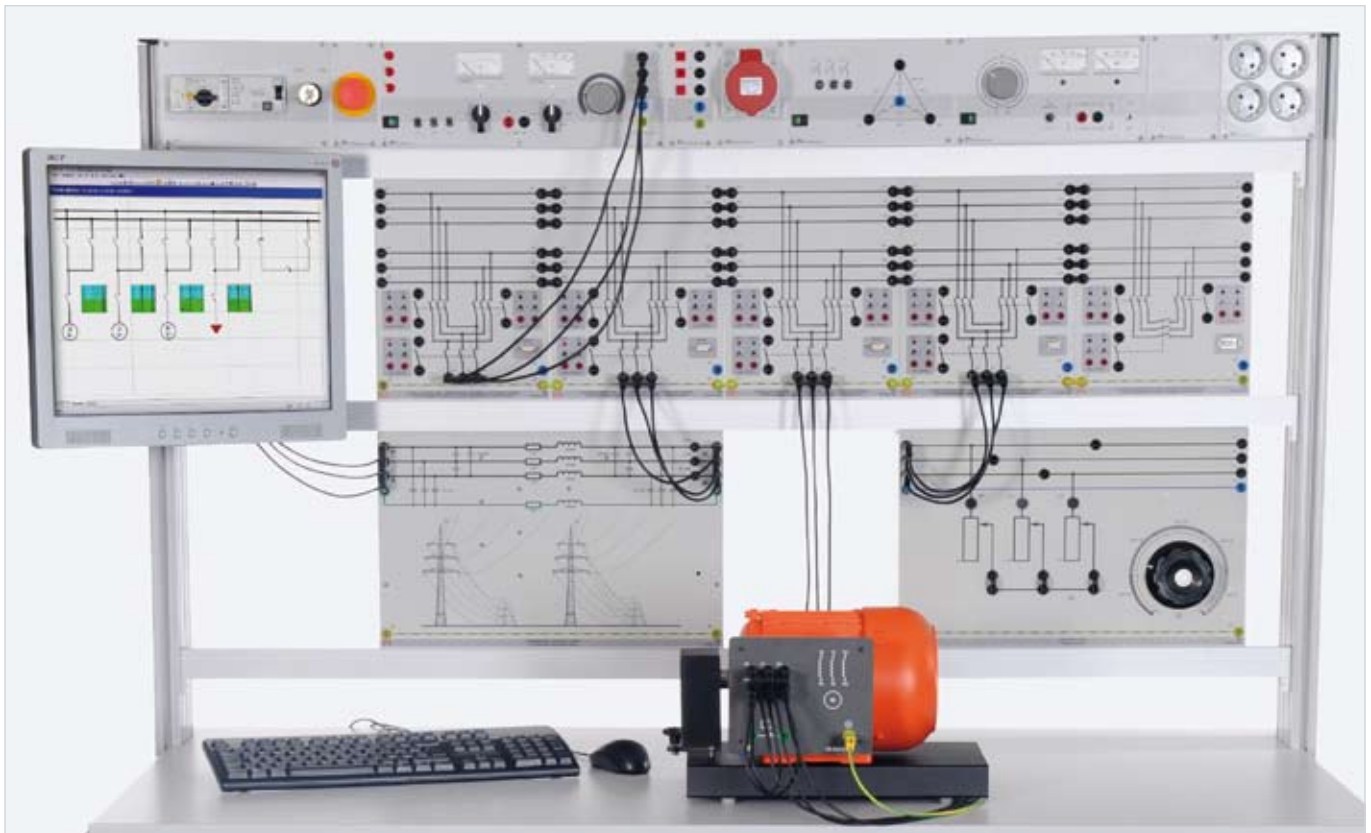

Sample experiment "Three-phase double busbar system" EPD

Training contents

- Basic circuits of a three-pole, double busbar system
- Three-phase, double busbar system with load
- Busbar changeover without interruption of the branch
- Preparation of algorithms for various switching operations
- Busbar coupling

Overcurrent Protection for Busbars

Due to the busbar's differential protection, the input and output currents are added up via a current transformer. In the case of differential currents, the characteristic sensitivity serves as a basis for determining trigger criteria.

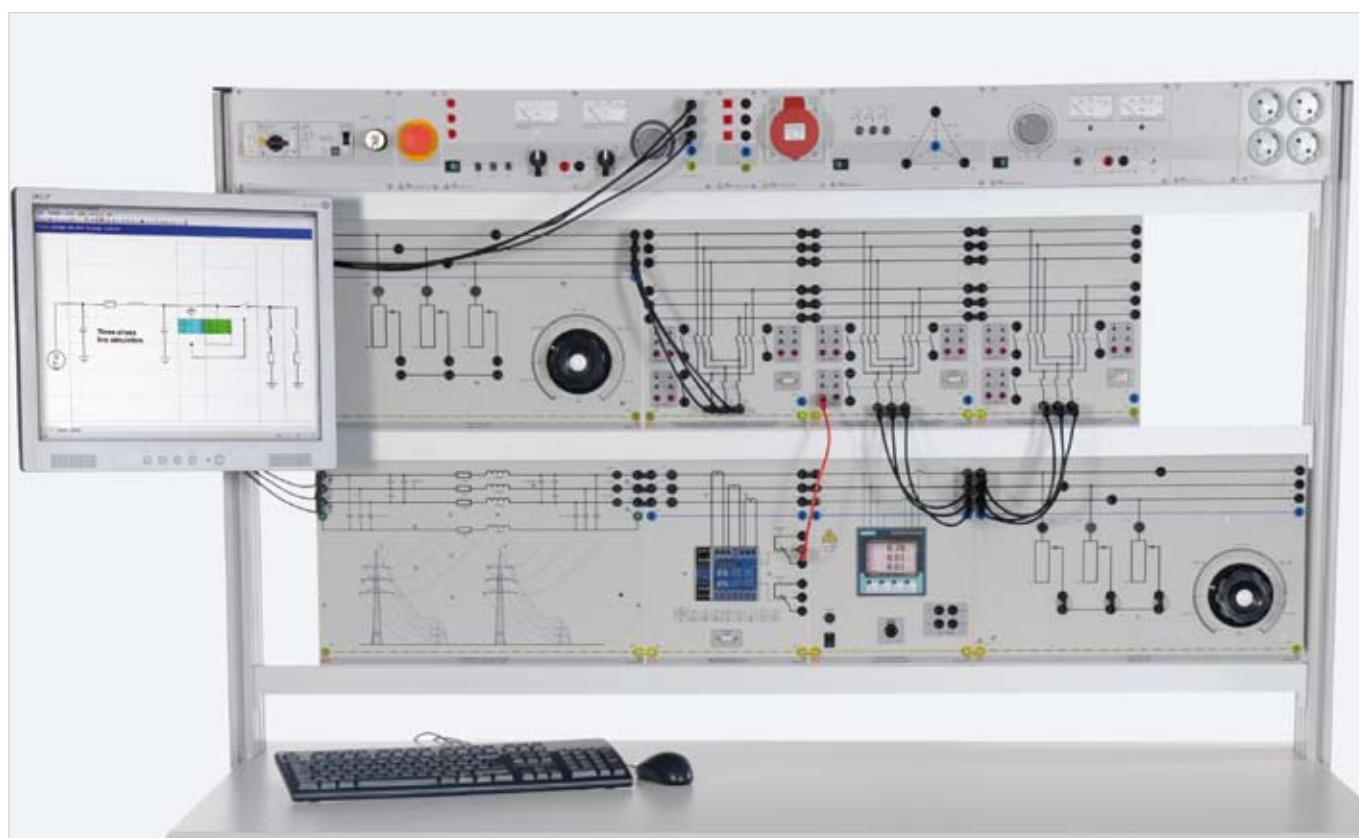

Sample experiment "Overcurrent protection for busbars" EPD

Training contents

- Registration of currents in normal operating mode
- Registration of currents in the event of single-, double- or triple-pole short circuit
- Faults outside the protective domain

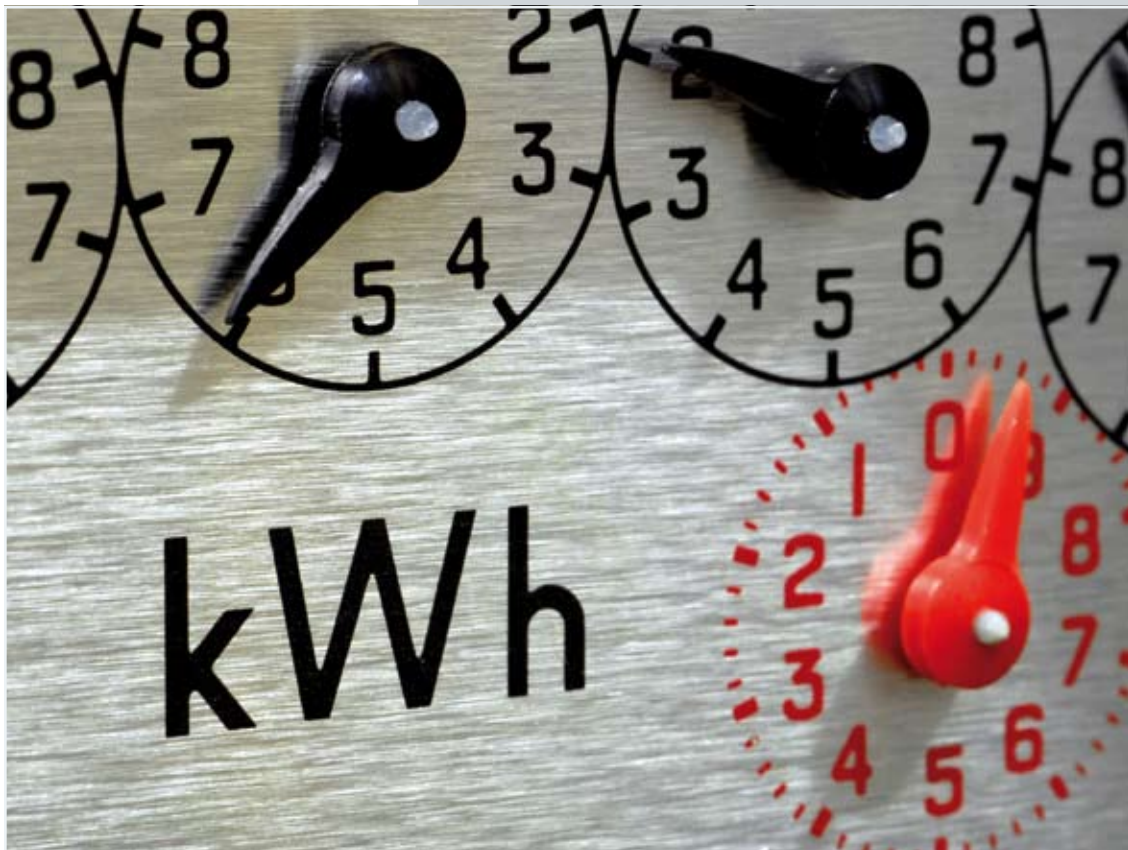

Energy Management

Complex Loads, Power Consumption Measurement and Peak Load Monitoring	88
Dynamic Loads	89
Manual and Automatic Compensation of Reactive Power	90
Protection of Electric Loads	91



Energy Management

Intelligent networks and loads

For economic and environmental reasons, a rational use of energy is becoming increasingly important. Exercises on manual and automatic compensation of reactive power as well as experiments on reducing peak loads through measurements with active-current and maximum-demand meters demonstrate how the load on a mains supply network can be reduced and evenly distributed over a 24-hour period. An analysis of the power supply grid and connected consumers (loads) is necessary for effective use of the involved measurement techniques. Accordingly, each experiment permits a detailed investigation of static, dynamic, symmetric and asymmetric loads. Protection of electrical consumers is another important training subject.



Smart metering

All energy technology kits contain intelligent measuring devices possessing a variety of communication interfaces (e.g. LAN, RS485, USB) and control elements. Consequently, consumers can not only be monitored, but also intelligently controlled. An automatic load management program can be realized with the features listed below:

- Monitoring of the specified power limit
- Enabling and disabling of consumers in accordance with a defined priority list
- Activation of consumers during minimum load periods



Source: SIEMENS

Protecting electrical consumers

Malfunctions in electrical systems resulting from short circuits, overload etc. must be prevented or at least restricted by means of appropriate protective measures, and the faulty devices disconnected selectively from the network. For the protective features to be properly implemented and correctly dimensioned, it is necessary to know their trigger characteristics and times, as well as their operational characteristics. This experiment series provides detailed treatment of how to protect three-phase motors by means of a motor protection switch, temperature monitoring in the coils, and triggering via a thermistor device. An experiment on full motor protection with a digital device can also be conducted. The handling and parametrization of the digital motor protection device are the focus of training in this experiment.

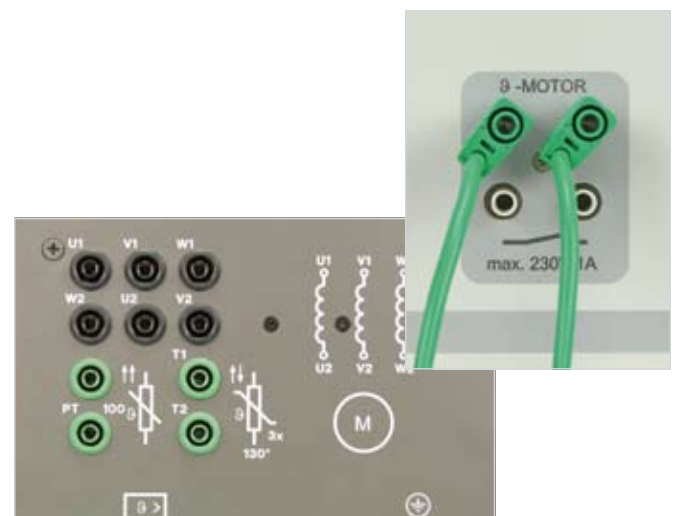

Training systems

Our training systems cover the following topics:

- Experiment panel group - "Complex loads, energy consumption measurement and peak load monitoring"
- Experiment panel group - "Dynamic loads"
- Experiment panel group - "Manual and automatic compensation of reactive power"
- Experiment panel group - "Protection of electric machines"
- Experiment panel group - "Motor protection/management"



Energy management

Complex Loads, Power Consumption Measurement and Peak Load Monitoring

Experiments on reducing peak loads through measurements with active-current and maximum-demand meters demonstrate how the load on a mains supply network can be reduced and evenly distributed over a 24-hour period. An analysis of the power supply grid and connected consumers (loads) is necessary for effective use of the measurement techniques involved. Accordingly, each experiment permits a detailed investigation of static, dynamic, symmetric and asymmetric loads.



Sample experiment "Measuring the power consumption of complex loads" EUC 1

Training contents

- Three-phase consumers with star and delta connections (R, L, C, RL, RC and RLC loads)
- Measurement with active and reactive energy meters:
 - for symmetric and asymmetric RL loads
 - in the event of a phase failure
 - in the event of over-compensation (RC load)
 - for active loads
 - in the event of energy-flow reversal
- Determination of the first and second power maxima
- Determination of the power maximum in the event of an asymmetric load
- Recording of load profiles

Dynamic Loads

In this case, a three-phase asynchronous motor coupled with the servo machine test stand is used as a dynamic load. The active and reactive powers (motor's $\cos\phi$) depend on the motor load and are therefore not constant. The servo machine test stand can be used to drive the asynchronous motor, thereby feeding active power into the three-phase network.



Sample experiment "Investigations on dynamic loads" EUC 2

Training contents

- Dynamic, three-phase load (asynchronous motor)
- Power measurement in the case of energy-flow reversal

Energy Management

Manual and Automatic Compensation of Reactive Power

Reactive power compensation in alternating voltage networks is designed to reduce undesirable reactive current and resultant reactive power of consumers. In this process, capacitive loads are connected to all inductive loads via a central feed point. The opposing, capacitive reactive power arising here is ideally of the same magnitude as the installed, inductive reactive power. This reduces undesirable reactive currents, and none of the systems needed to supply the reactive current has to be over-dimensioned.



Sample experiment "Automatic compensation of reactive power" EUC 3

Training contents

- Operating an asynchronous machine and recording its characteristic parameters
- Calculating parameters for compensation capacitors
- Compensation using various capacitors
- Determining stage power
- Manual compensation of reactive power
- Automatic identification of a reactive power controller's connections
- Automatic compensation of reactive power

Protection of Electric Loads

Three-phase Asynchronous Machines

Squirrel-cage motors are designed for operation under constant load conditions. Changes in load or excessively high starting currents can cause such motors to heat up beyond permitted levels. Sensors are therefore used to monitor the motor's temperature and current consumption.

As required, these sensors activate protective features such as the motor protection switch, motor protection relay and thermistor relay.



Sample experiment "Protection of electric machines" EEM 4.6

Training contents

- Selecting, installing and setting various motor protection systems
- Motor protection switch
- Motor protection relay
- Thermistor protection
- Effect of various operating modes on motor heating
- Trigger characteristics of protective systems
- Protection against impermissible load states

Protection of Electric Loads

Effective Motor Protection – Preventive Maintenance

Used as part of modern automation technology, motor management systems make it possible to optimally protect, control and monitor drives and related equipment. Parameters such as motor temperature, voltage and current can be registered in this way. Linkage to higher-level process automation via field bus systems (e.g. PROFIBUS) makes the motor's operation more transparent. As a result, the motor's utilization level and energy consumption can be monitored without having to perform in-situ measurements.



Sample experiment "Motor management relay" EDT 51

Training contents

- PC-supported operation of a motor management system
- Programming of functions such as direct start, star-delta start, reversible-pole motor start, motor protection
- Parametrization of overload variables and switch-off response under various loads
- Measurement of dynamic processes during starting
- Preventive maintenance

Training Systems for Electronic Equipment

Supplementary experiments on electrical power engineering can be found at:

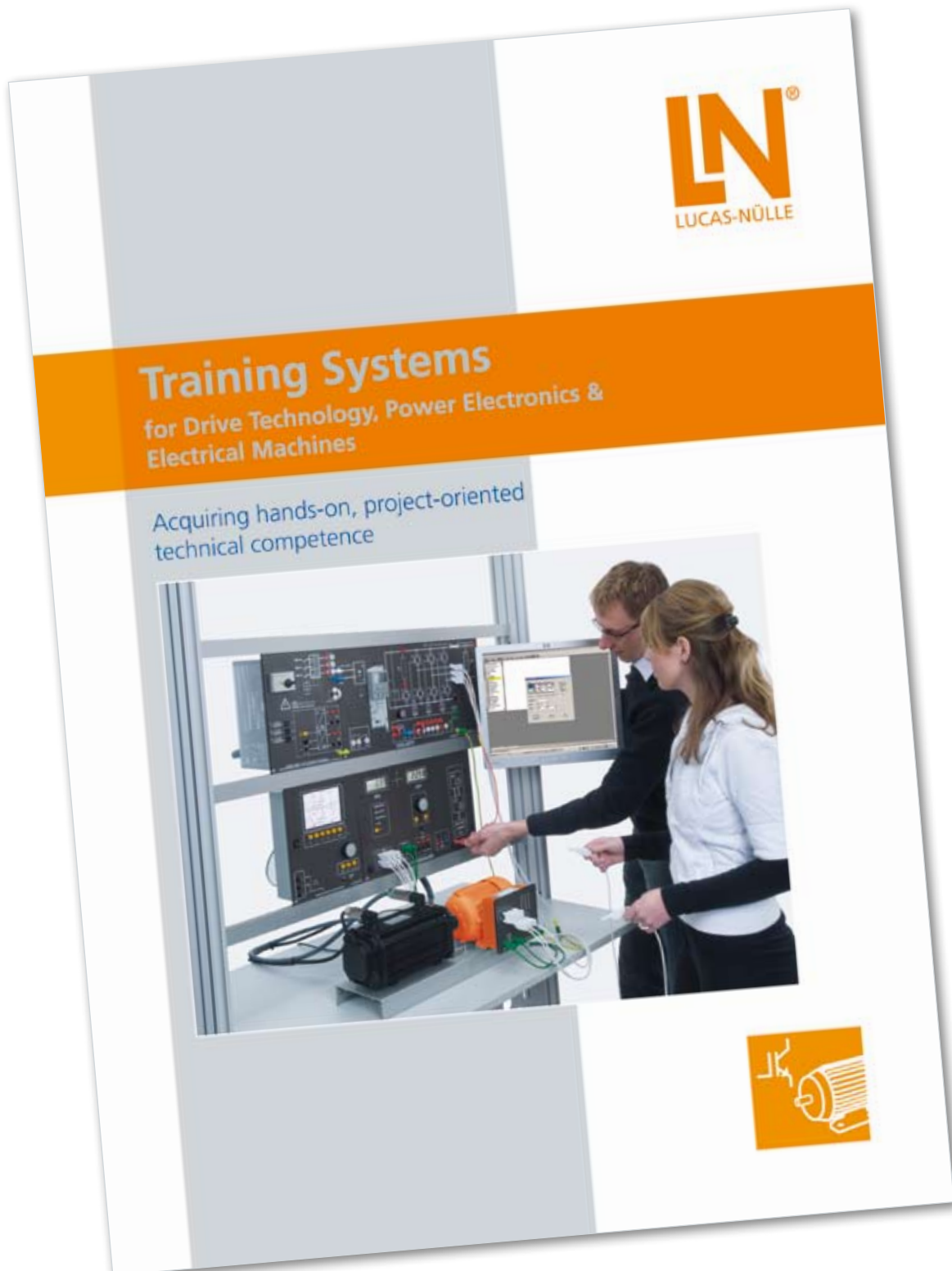

Decisive Product Benefits

... ensure Long-term Customer Satisfaction



Herr Prof. Guntram Schultz, Dean at the University of Applied Sciences in Karlsruhe, Department of Electrical Engineering and Information Technology:

"I am a huge fan of electrical power engineering from Lucas-Nülle. The extensive programme facilitates innumerable analyses of such fields as power generation and distribution technology – including mains protection – as well as energy consumption.

Thanks to the modularly designed three-phase training panel system, system relationships can be explored step by step within the experiment.

Moreover, the high potential for expandability facilitates seamless integration of renewable energies into conventional power engineering. No other manufacturer provides a system which demonstrates such flexibility and which can be reconfigured again and again depending on requirements.

A particular advantage is in my view the consistent use of the electrical scale of 1:1000 which enables measurement findings to be compared directly with real measurements. Realistic line simulations at the variable length level facilitate the deployment of conventional industrial equipment for reality-based project work in a safe lab environment. The SCADA system enables optimal experiment monitoring and control while data evaluation processes are second to none. The materials which come in the form of multi-media courses are very attractively designed and are popular with students.

Meanwhile the quality of the individual experiment components, combined with a proven didactic concept, are the factors which appeal most to lecturers.

All of this is by way of explaining why we chose Lucas-Nülle. Using the programme as a whole, we can plan the entire electrical power engineering course systematically while familiarising students with typical industrial applications in a focussed manner. "

The Whole is Greater than the Sum of its Parts

Individual consultation with Lucas-Nülle

Do you require detailed advice or a specific quotation?

You can contact us as follows:

Phone: +49 2273 567-0

Fax: +49 2273 567-39

Lucas-Nülle is a byword for customized vocational training systems in the following areas:



Installation Engineering



Electropneumatics, Hydraulics



Electrical Power Engineering



Instrumentation



Power Electronics, Electrical Machines,
Drive Technology



Microcontrollers



Electrical and Electronic Circuits



Automation Technology



Communications Technology



Automotive Technology



Process Control



Lab Systems

Ask for detailed information via any of the contact methods mentioned above.
Our employees will be happy to advise you.

Lucas-Nülle training systems meet the highest safety and quality standards. Changes in areas like environmental protection, customer benefits, design and construction entail corresponding advancements to systems or components. This can lead to discrepancies between product details and relevant items in the scope of delivery.

Further information on our products can also be found at:

www.lucas-nuelle.com

www.unitrain-i.com

Lucas-Nülle Lehr- und Meßgeräte GmbH

Siemensstraße 2 · D-50170 Kerpen-Sindorf · Germany
Telephone: +49 2273 567-0 · Fax: +49 2273 567-39
www.lucas-nuelle.com

